

DUKANE

Portable LCD Projector

Models 8762



User's Manual

- Digital Light Processing and DLP are trademarks of Texas Instruments.
- IBM is a trademark or registered trademark of International Business Machines Corporation.
- Macintosh, Mac OS X and PowerBook are trademarks of Apple Computer, Inc., registered in the U.S. and other countries.
- Windows, Windows 98, Windows Me, Windows XP or Windows 2000 are trademarks or registered trademarks of Microsoft Corporation.
- Other product and company names mentioned in this user's manual may be the trademarks or registered trademarks of their respective holders.

NOTES

- (1) The contents of this guide may not be reprinted in part or whole without permission.
- (2) The contents of this guide are subject to change without notice.
- (3) Great care has been taken in the preparation of this manual; however, should you notice any questionable points, errors or omissions, please contact us.
- (4) Notwithstanding article (3), Dukane will not be responsible for any claims on loss of profit or other matters deemed to result from using the Projector.

Important Information

Safety Cautions

Precautions

Please read this manual carefully before using your 8762 projector and keep the manual handy for future reference. Your serial number is located on the bottom of your projector. Record it here:

CAUTION



To turn off main power, be sure to remove the plug from power outlet. The power outlet socket should be installed as near to the equipment as possible, and should be easily accessible.

CAUTION



TO PREVENT SHOCK, DO NOT OPEN THE CABINET. THERE ARE HIGH-VOLTAGE COMPONENTS INSIDE. REFER SERVICING TO QUALIFIED SERVICE PERSONNEL.



This symbol warns the user that uninsulated voltage within the unit may be sufficient to cause electrical shock. Therefore, it is dangerous to make any kind of contact with any part inside of the unit.



This symbol alerts the user that important information concerning the operation and maintenance of this unit has been provided. The information should be read carefully to avoid problems.

WARNING: TO PREVENT FIRE OR SHOCK, DO NOT EXPOSE THIS UNIT TO RAIN OR MOISTURE. DO NOT USE THIS UNIT'S PLUG WITH AN EXTENSION CORD OR IN AN OUTLET UNLESS ALL THE PRONGS CAN BE FULLY INSERTED.

DOC Compliance Notice (for Canada only)

This Class B digital apparatus meets all requirements of the Canadian Interference-Causing Equipment Regulations.

Acoustic Noise Information Ordinance-3. GSGV (for Germany only):

The sound pressure level is less than 70 dB (A) according to ISO 3744 or ISO 7779.

Disposing of your used product



EU-wide legislation as implemented in each Member State requires that used electrical and electronic products carrying the mark (left) must be disposed of separately from normal household waste. This includes projectors and their electrical accessories or lamps. When you dispose of such products, please follow the guidance of your local authority and/or ask the shop where you purchased the product.

After collecting the used products, they are reused and recycled in a proper way. This effort will help us reduce the wastes as well as the negative impact such as mercury contained in a lamp to the human health and the environment at the minimum level.

The mark on the electrical and electronic products only applies to the current European Union Member States.

WARNING TO CALIFORNIA RESIDENTS:

Handling the cables supplied with this product, will expose you to lead, a chemical known to the State of California to cause birth defects or other reproductive harm. Wash hands after handling.

RF Interference (for USA only)

WARNING

The Federal Communications Commission does not allow any modifications or changes to the unit EXCEPT those specified by NEC Solutions (America), Inc. in this manual. Failure to comply with this government regulation could void your right to operate this equipment. This equipment has been tested and found to comply with the limits for a Class B digital device, pursuant to Part 15 of the FCC Rules. These limits are designed to provide reasonable protection against harmful interference in a residential installation. This equipment generates, uses, and can radiate radio frequency energy and, if not installed and used in accordance with the instructions, may cause harmful interference to radio communications. However, there is no guarantee that interference will not occur in a particular installation.

If this equipment does cause harmful interference to radio or television reception, which can be determined by turning the equipment off and on, the user is encouraged to try to correct the interference by one or more of the following measures:

- Reorient or relocate the receiving antenna.
- Increase the separation between the equipment and receiver.
- Connect the equipment into an outlet on a circuit different from that to which the receiver is connected.
- Consult the dealer or an experienced radio / TV technician for help.

For UK only: In UK, a BS approved power cable with moulded plug has a Black (five Amps) fuse installed for use with this equipment. If a power cable is not supplied with this equipment please contact your supplier.

Important Safeguards

These safety instructions are to ensure the long life of your projector and to prevent fire and shock. Please read them carefully and heed all warnings.

Installation

- Do not place the projector in the following conditions:
 - on an unstable cart, stand, or table.
 - near water, baths or damp rooms.
 - in direct sunlight, near heaters or heat radiating appliances.
 - in a dusty, smoky or steamy environment.
 - on a sheet of paper or cloth, rugs or carpets.
- If you wish to have the projector installed on the ceiling:
 - Do not attempt to install the projector yourself.
 - The projector must be installed by qualified technicians in order to ensure proper operation and reduce the risk of bodily injury.
 - In addition, the ceiling must be strong enough to support the projector and the installation must be in accordance with any local building codes.
 - Please consult your dealer for more information.

Place the projector in a horizontal position

The tilt angle of the projector should not exceed 10 degrees, nor should the projector be installed in any way other than the desktop and ceiling mount, otherwise lamp life could decrease dramatically.



Fire and Shock Precautions

- Ensure that there is sufficient ventilation and that vents are unobstructed to prevent the build-up of heat inside your projector. Allow at least 4 inches (10cm) of space between your projector and a wall.
- Do not try to touch the ventilation outlet on the right front (when seen from the front) as it can become heated while the projector is turned on and immediately after the projector is turned off.
- Prevent foreign objects such as paper clips and bits of paper from falling into your projector. Do not attempt to retrieve any objects that might fall into your projector. Do not insert any metal objects such as a wire or screwdriver into your project. If something should fall into your projector, disconnect it immediately and have the object removed by a qualified service personnel.
- Do not place any objects on top of the projector.
- Do not touch the power plug during a thunderstorm. Doing so can cause electrical shock or fire.
- The projector is designed to operate on a power supply of 100-240V AC 50/60 Hz. Ensure that your power supply fits this requirement before attempting to use your projector.
- Do not look into the lens while the projector is on. Serious damage to your eyes could result.
- Keep any items such as magnifying glass out of the light path of the projector. The light being projected from the lens is extensive, therefore any kind of abnormal objects that can redirect light coming out of the lens, can cause unpredictable outcome such as fire or injury to the eyes.
- Do not cover the lens with the black lens cap or equivalent while the projector is on. Doing so can lead to melting of the cap and possibly burning your hands due to the heat emitted from the light output.
- Do not place any objects, which are easily affected by heat, in front of the projector lens or a projector exhaust vent. Doing so could lead to the object melting or getting your hands burned from the heat that is emitted from the light output and exhaust.
- Handle the power cable carefully. A damaged or frayed power cable can cause electric shock or fire.
 - Do not use any power cables than the supplied one.
 - Do not bend or tug the power cable excessively.
 - Do not place the power cable under the projector, or any heavy object.
 - Do not cover the power cable with other soft materials such as rugs.
 - Do not heat the power cable
 - Do not handle the power plug with wet hands.
- Turn off the projector, unplug the power cable and have the object removed by a qualified NEC service personnel under the following conditions:
 - When the power cable or plug is damaged or frayed.
 - If liquid has been spilled into the projector, or if it has been exposed to rain or water.
 - If the projector does not operate normally when you follow the instructions described in this user's manual.
 - If the projector has been dropped or the cabinet has been damaged.
 - If the projector exhibits a distinct change in performance, indicating a need for service.
 - If the projector is not to be used for an extended period of time.
- Disconnect the power cable and any other cables before carrying the projector
- Turn off the projector and unplug the power cable before cleaning the cabinet or replacing the lamp.

CAUTION

- Do no use the tilt-foot for purposes other than originally intended. Misuses such as using the tilt foot to carry or hang (from the wall or ceiling) the projector can cause damage to the projector.
- Do not send the projector in the soft case by parcel delivery service or cargo shipment. The projector inside the soft case could be damaged.
- Select [High] in Fan mode if you continue to use the projector for consecutive days. (From the menu, select [Setup - Options] → [Fan Mode] → [High].)
- Do not unplug the power cable from the wall outlet or projector when the projector is powered on. Doing so can cause damage to the AC IN connector of the projector and (or) the prong plug of the power cable.
- Do not turn off the AC power for 60 seconds after the lamp is turned on and while the POWER indicator is blinking green.
Doing so could cause premature lamp failure.

Remote Control Precautions

- Handle the remote control carefully.
- If the remote control gets wet, wipe it dry immediately.
- Avoid excessive heat and humidity.
- Do not heat, take apart, or throw batteries into fire.
- If you will not be using the remote control for a long time, remove the batteries.
- Ensure that you have the batteries' polarity (+/-) aligned correctly.
- Do not use new and old batteries together, or use different types of batteries together.
- Dispose of used batteries according to your local regulations.

Lamp Replacement

- To replace the lamp, follow all instructions provided on page [47](#) to [49](#).
- Be sure to replace the lamp when the message **[The lamp has reached the end of its usable life. Please replace the lamp.]** appears. If you continue to use the lamp after the lamp has reached the end of its usable life, the lamp bulb may shatter, and pieces of glass may be scattered in the lamp case. Do not touch them as the pieces of glass may cause injury.

If this happens, contact your dealer for lamp replacement.

A Lamp Characteristic

The projector has a high-pressure mercury lamp as a light source.

A lamp has a characteristic that its brightness gradually decreases with age. Also repeatedly turning the lamp on and off will increase the possibility of its lower brightness.

CAUTION:

When removing the lamp from a ceiling-mounted projector, make sure that no one is under the projector. Glass fragments could fall if the lamp has been burned out.

Table of Contents

Important Information	i
1. Introduction	1
1 What's in the Box?	1
2 Introduction to the Projector	2
3 Part Names of the Projector	4
Top Features	6
Terminal Panel Features	6
4 Part Names of the Remote Control	7
Battery Installation	8
Remote Control Precautions	8
Operating Range for Wireless Remote Control	8
2. Installation and Connections	9
1 Setting Up the Screen and the Projector	9
Selecting a Location	9
Throw Distance and Screen Size	10
2 Making Connections	12
Connecting Your PC or Macintosh Computer	12
To connect SCART output (RGB)	13
Connecting Your DVD Player with Component Output	14
Connecting Your VCR or Laser Disc Player	15
Connecting the Supplied Power Cable	16
3. Projecting an Image (Basic Operation)	17
1 Turning on the Projector	17
Note on Startup Screen (Menu Language Select screen)	18
2 Selecting a Source	19
3 Adjusting the Picture Size and Position	20
4 Adjusting Focus Manually	24
5 Correcting Keystone Distortion Manually	25
6 Optimizing RGB Picture Automatically	26
7 Adjusting Volume Up or Down	26
8 Turning off the Projector	27
9 After Use	27

4. Convenient Features	28
1 Turning Off the Image and Sound	28
2 Freezing a Picture	28
3 Changing Lamp Mode	28
4 Preventing the Unauthorized Use of the Projector	28
5 Using the Optional Remote Mouse Receiver	31
5. Using On-Screen Menu	32
1 Using the Menus	32
2 Menu Elements	34
3 List of Menu Items	35
4 Menu Descriptions & Functions [Picture]	37
5 Menu Descriptions & Functions [Image Options]	38
6 Menu Descriptions & Functions [Setup]	40
[Setup - General]	40
[Setup - Installation]	41
[Setup - Options]	43
7 Menu Descriptions & Functions [Information]	44
8 Menu Descriptions & Functions [Reset]	45
6. Maintenance	46
1 Cleaning the Lens and the Focus Sensor	46
2 Cleaning the Cabinet	46
3 Replacing the Lamp	47
7. Appendix	50
1 Troubleshooting	50
2 Specifications	53
3 Cabinet Dimensions	55
4 Pin Assignments of D-Sub COMPUTER Input Connector	56
5 Compatible Input Signal List	57
6 PC Control Codes and Cable Connection	58
7 Troubleshooting Check List	59

1. Introduction

① What's in the Box?

Make sure your box contains everything listed. If any pieces are missing, contact your dealer. Please save the original box and packing materials if you ever need to ship your projector.

Projector

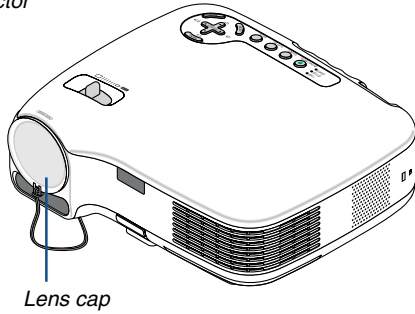

Lens cap

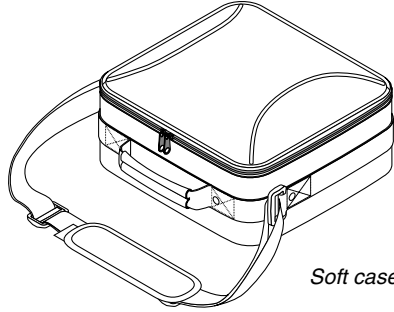

Soft case

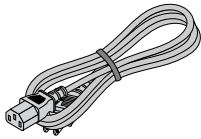

*Power cable
(US: 7N080204)*

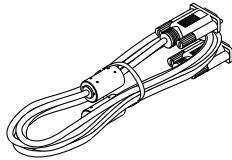

VGA signal cable

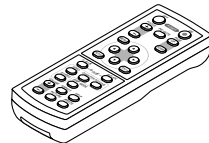

*Remote control
(7N900681)*

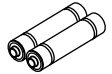

Batteries (AAA × 2)

2 Introduction to the Projector

This section introduces you to your new projector and describes the features and controls.

Congratulations on Your Purchase of the Projector

This projector is one of the very best projectors available today. The projector enables you to project precise images up to 300 inches across (measured diagonally) from your PC or Macintosh computer (desktop or notebook), VCR, DVD player, document camera, or a laser disc player.

You can use the projector on a tabletop or cart, you can use the projector to project images from behind the screen, and the projector can be permanently mounted on a ceiling*¹. The remote control can be used wirelessly.

*¹ Do not attempt to mount the projector on a ceiling yourself.

The projector must be installed by qualified technicians in order to ensure proper operation and reduce the risk of bodily injury.

In addition, the ceiling must be strong enough to support the projector and the installation must be in accordance with any local building codes. Please consult your dealer for more information.

Features you'll enjoy:

- Auto Focus function

When you turn on the power, change the zoom or reposition the projector, the Auto Focus function will work instantly.

The focus sensor on the projector detects the distance to the screen and automatically adjusts the focus of an image as well as reducing the required set-up time.

- Auto vertical keystone correction up to +/- 16 degrees
- Built-in Wall Color Correction presets provide for adaptive color correction when projecting onto non-white screen material
- Direct Power Off
The projector has a feature called "Direct Power Off". This feature allows the projector to be turned off (even when projecting an image) using a power strip equipped with a switch and a breaker.
Also, the power cable can be removed immediately after turning off the projector.
- HDTV (1080i, 720p) and SDTV (576p, 480p) compatibility
- Integrated de-interlace video processing technology
- Display popular wide screen and full screen aspect ratios – 16:9 and 4:3
- Built-in speaker for an integrated audio solution
- High resolution display - up to SXGA+ compatible, XGA native resolution.
- Multiple video mode selections (depending on your source)
- Safety protect by Security function
Security feature prevents unauthorized individuals from displaying images.
- You can control the projector with a PC or control system using the PC Control port.
- Easy set up and operation
- The contemporary cabinet design is light, compact and complements any office, boardroom or Auditorium.

About this user's manual

The fastest way to get started is to take your time and do everything right the first time. Take a few minutes now to review the user's manual. This may save you time later on. At the beginning of each section of the manual you'll find an overview. If the section doesn't apply, you can skip it.

3 Part Names of the Projector

Front/Top

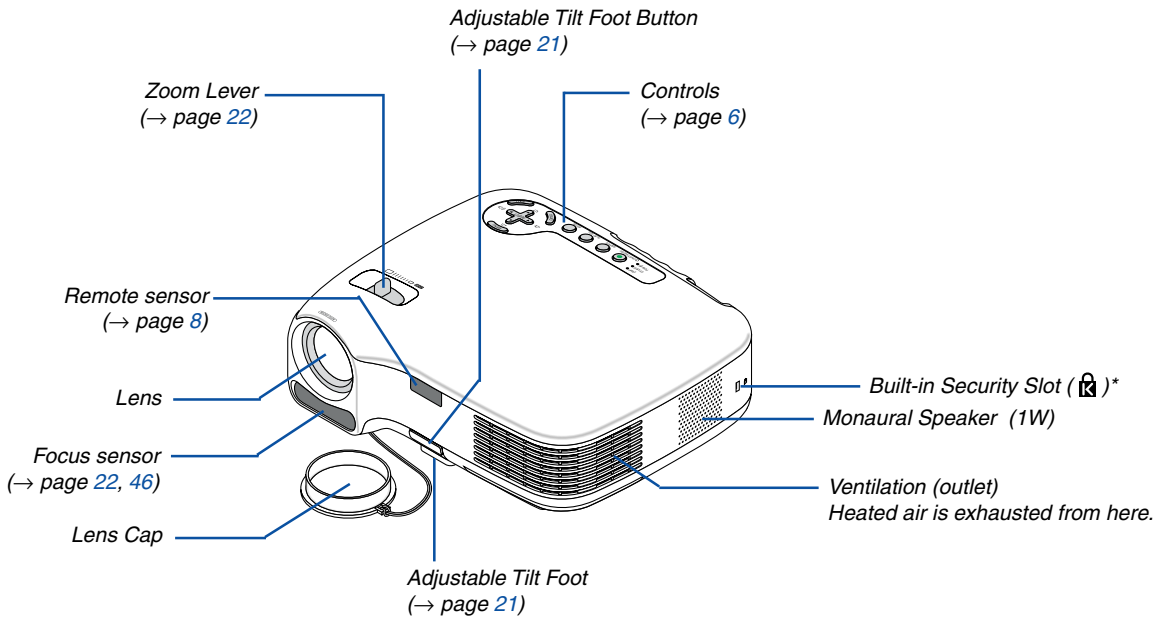

* This security slot supports the MicroSaver ® Security System. MicroSaver ® is a registered trademark of Kensington Microware Inc. The logo is trademarked and owned by Kensington Microware Inc.

Rear

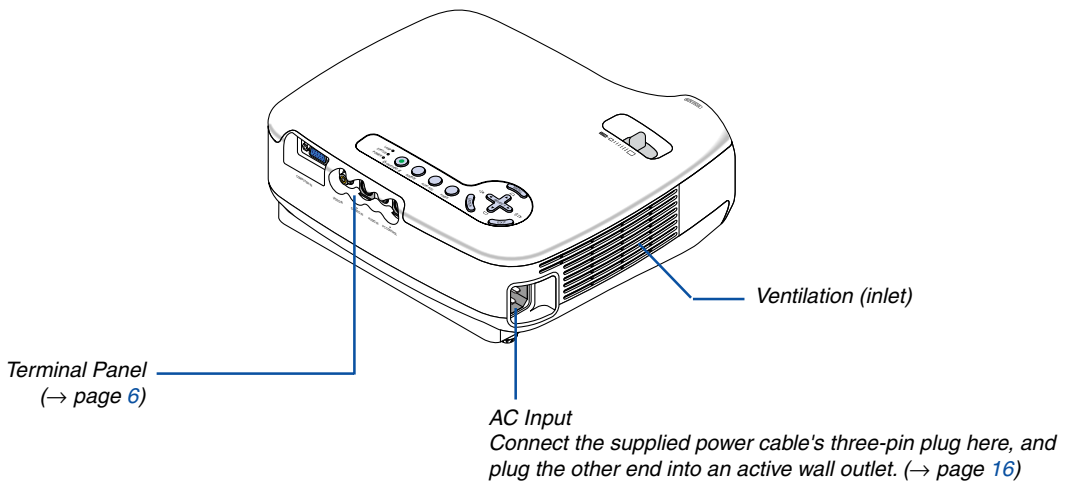

Bottom

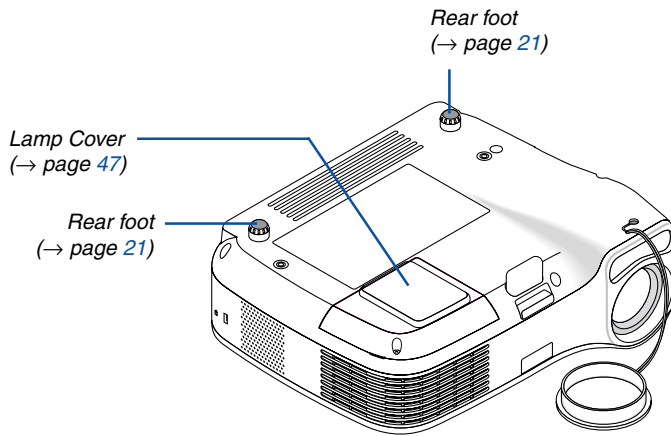

Top Features

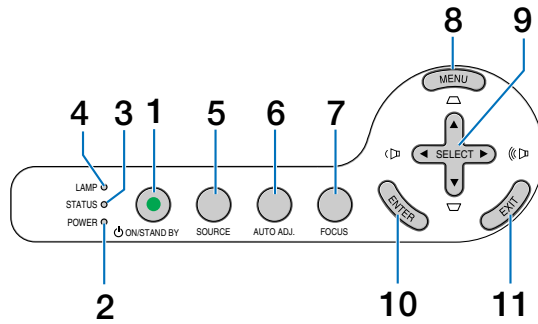

- | | |
|--|---|
| <ul style="list-style-type: none"> 1. POWER Button (ON / STAND BY) (⏻) (→ page 17, 27) 2. POWER Indicator (→ page 16, 17, 27, 50) 3. STATUS Indicator (→ page 50) 4. LAMP Indicator (→ page 47, 50) 5. SOURCE Button (→ page 19) 6. AUTO ADJ. Button (→ page 26) | <ul style="list-style-type: none"> 7. FOCUS Button (→ page 24) 8. MENU Button 9. SELECT ▲▼◀▶/ Volume ◀▶/ Keystone ▲▼ Buttons 10. ENTER Button 11. EXIT Button |
|--|---|

Terminal Panel Features

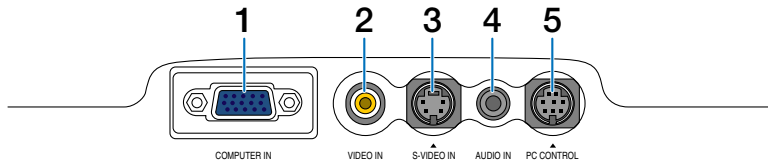

- | | |
|---|--|
| <ul style="list-style-type: none"> 1. COMPUTER IN/ Component Input Connector (Mini D-Sub 15 Pin) (→ page 12, 13, 14) 2. VIDEO IN Connector (RCA) (→ page 15) 3. S-VIDEO IN Connector (Mini DIN 4 Pin) (→ page 15) 4. AUDIO IN Mini Jack (Stereo Mini) (→ page 12, 14) | <ul style="list-style-type: none"> 5. PC CONTROL Port (Mini DIN 8 Pin) (→ page 58)
Use this port to connect a PC or control system. This enables you to control the projector using serial communication protocol. If you are writing your own program, typical PC control codes are on page 58. |
|---|--|

4 Part Names of the Remote Control

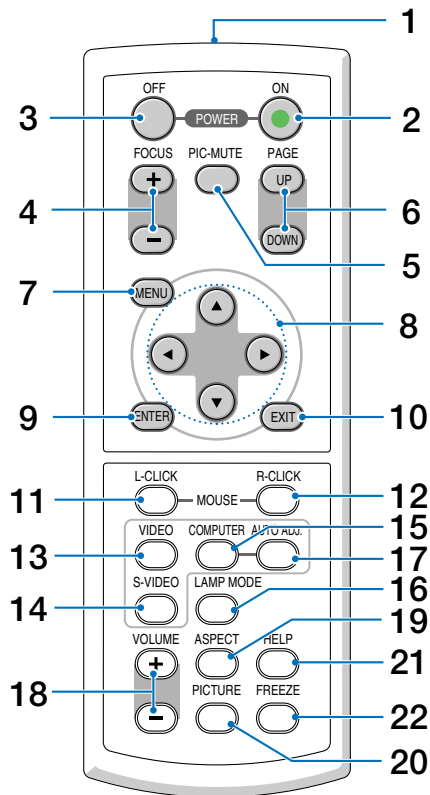

- | | |
|---|---------------------------------------|
| 1. Infrared Transmitter (→ page 8) | 12. R-CLICK MOUSE Button* (→ page 31) |
| 2. POWER ON Button (→ page 17) | 13. VIDEO Button (→ page 19) |
| 3. POWER OFF Button (→ page 27) | 14. S-VIDEO Button (→ page 19) |
| 4. FOCUS (+) (-) Button (→ page 24) | 15. COMPUTER Button (→ page 19) |
| 5. PIC-MUTE Button (→ page 28) | 16. LAMP MODE Button (→ page 28) |
| 6. PAGE (UP) / (DOWN) Button* (→ page 31) | 17. AUTO ADJ. Button (→ page 26) |
| 7. MENU Button | 18. VOLUME (+) (-) Button (→ page 26) |
| 8. SELECT Buttons | 19. ASPECT Button (→ page 38) |
| 9. ENTER Button | 20. PICTURE Button (→ page 37, 38) |
| 10. EXIT Button | 21. HELP Button (→ page 44) |
| 11. L-CLICK MOUSE Button* (→ page 31) | 22. FREEZE Button (→ page 28) |

* Available only when the optional remote mouse receiver is connected with your computer.

Battery Installation

1 Press firmly and slide the battery cover off.

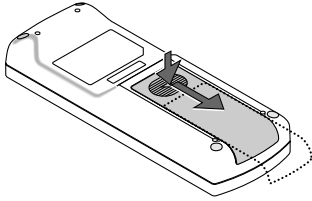

2 Install new batteries (AAA). Ensure that you have the batteries' polarity (+/-) aligned correctly.

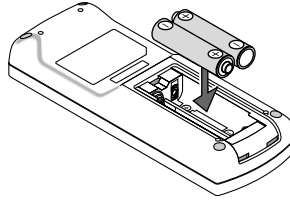

3 Slip the cover back over the batteries until it snaps into place. Do not mix different types of batteries or new and old batteries.

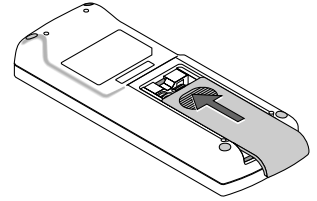

Remote Control Precautions

- Handle the remote control carefully.
- If the remote control gets wet, wipe it dry immediately.
- Avoid excessive heat and humidity.
- Do not heat, take apart, or throw batteries into fire.
- If you will not be using the remote control for a long time, remove the batteries.
- Ensure that you have the batteries' polarity (+/-) aligned correctly.
- Do not use new and old batteries together, or use different types of batteries together.
- Dispose of used batteries according to your local regulations.

Operating Range for Wireless Remote Control

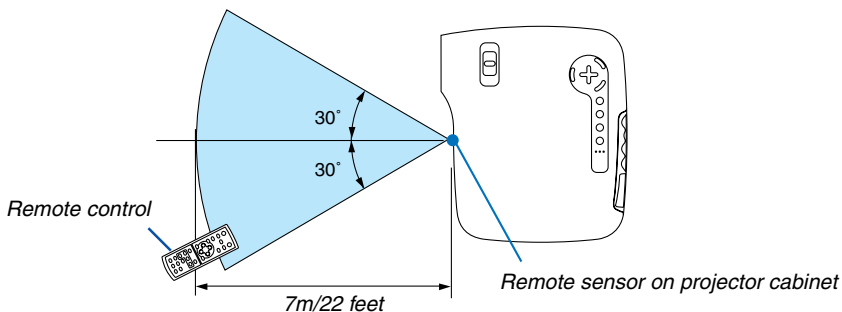

- The infrared signal operates by line-of-sight up to a distance of about 22 feet/7 m and within a 60-degree angle of the remote sensor on the projector cabinet.
- The projector will not respond if there are objects between the remote control and the sensor, or if strong light falls on the sensor. Weak batteries will also prevent the remote control from properly operating the projector.

2. Installation and Connections

This section describes how to set up your projector and how to connect video and audio sources.

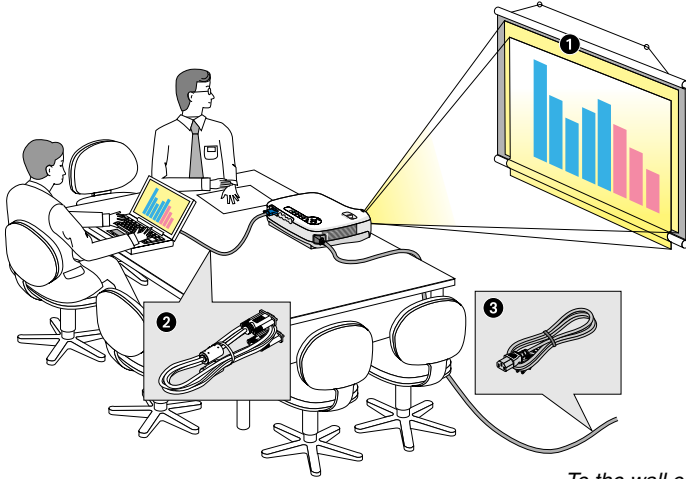

To the wall outlet.

Your projector is simple to set up and use. But before you get started, you must first:

- ❶ Set up a screen and the projector.
- ❷ Connect your computer or video equipment to the projector. See pages 12 to 15.
- ❸ Connect the supplied power cable. See page 16.

NOTE: Ensure that the power cable and any other cables are disconnected before moving the projector. When moving the projector or when it is not in use, cover the lens with the lens cap.

❶ Setting Up the Screen and the Projector

Selecting a Location

The further your projector is from the screen or wall, the larger the image. The minimum size the image can be is approximately 30" (0.76 m) measured diagonally when the projector is roughly 47 inches (1.2 m) from the wall or screen. The largest the image can be is 300" (7.6 m) when the projector is about 480 inches (12.2 m) from the wall or screen. Use the chart below as a rough guide.

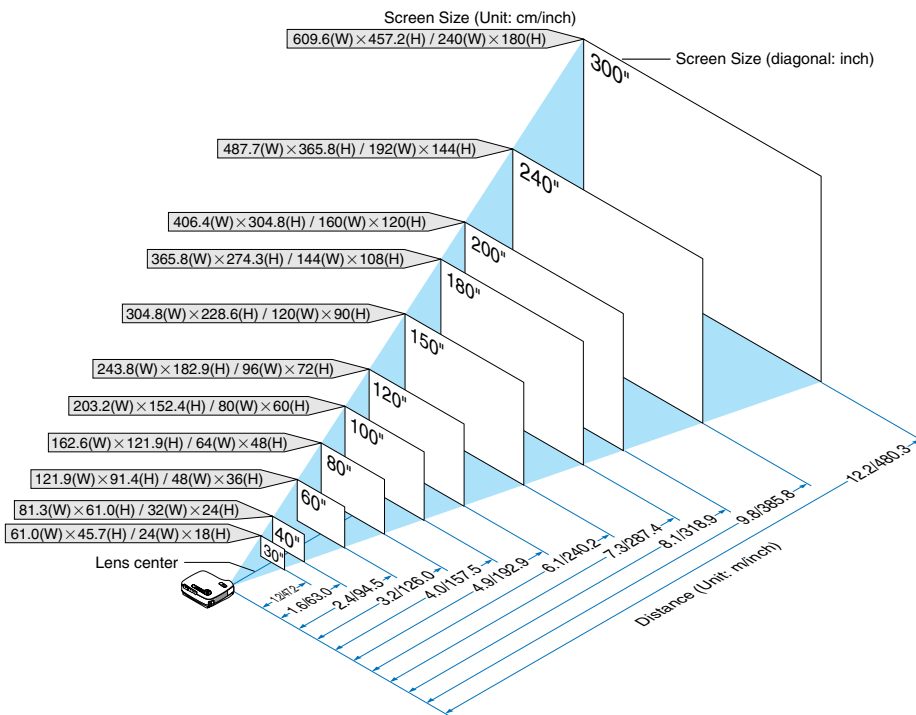

NOTE:

- The distances are indicated by intermediate values between tele and wide. Use as a rule of thumb.
- The Zoom lever adjusts the image size up to +/-10%
- For more details on throw distance, see next page.
- Changing the image size starts the Auto Focus to adjust the focus; changing the throw angle starts the Auto Keystone to correct the vertical keystone distortion.

2. Installation and Connections

Throw Distance and Screen Size

The following shows the proper relative positions of the projector and screen. Refer to the table to determine the position of installation.

Distance Chart

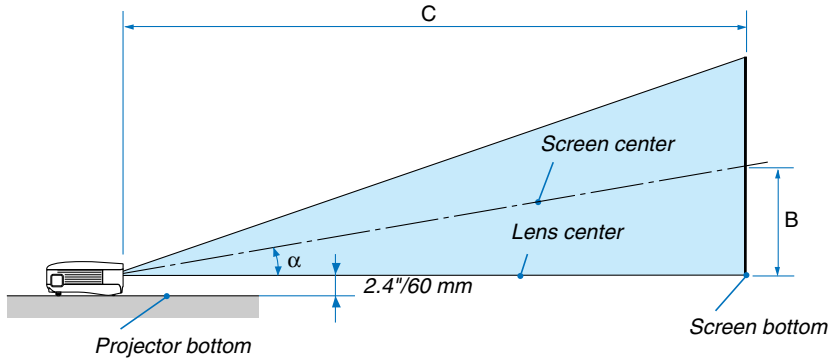

B = Vertical distance between lens center and screen center

C = Throw distance

α = Throw angle

NOTE: Distances may vary +/-5%.

Screen Size			B	C		α
Diagonal	Width	Height		Wide - Tele	Wide - Tele	degree
inch	inch	inch	inch	inch	inch	degree
30	24	18	9	42 - 51	12.1 - 10.0	
40	32	24	12	57 - 69	11.9 - 9.9	
60	48	36	18	86 - 104	11.8 - 9.9	
67	54	40	20	96 - 116	11.8 - 9.9	
72	58	43	22	104 - 125	11.7 - 9.8	
80	64	48	24	115 - 139	11.8 - 9.8	
84	67	50	25	121 - 146	11.7 - 9.8	
90	72	54	27	130 - 156	11.7 - 9.8	
100	80	60	30	145 - 174	11.7 - 9.8	
120	96	72	36	174 - 209	11.7 - 9.8	
150	120	90	45	218 - 261	11.7 - 9.8	
180	144	108	54	262 - 314	11.7 - 9.8	
200	160	120	60	291 - 349	11.6 - 9.7	
220	176	132	66	320 - 384	11.6 - 9.7	
240	192	144	72	350 - 419	11.6 - 9.7	
260	208	156	78	379 - 454	11.6 - 9.7	
280	224	168	84	408 - 489	11.6 - 9.7	
300	240	180	90	438 - 524	11.6 - 9.7	

Screen Size			B	C		α
Diagonal	Width	Height		Wide - Tele	Wide - Tele	degree
mm	mm	mm	mm	mm	mm	degree
762	610	457	229	1070 - 1290	12.1 - 10.0	
1016	813	610	305	1450 - 1740	11.9 - 9.9	
1524	1219	914	457	2190 - 2630	11.8 - 9.9	
1702	1361	1021	511	2450 - 2940	11.8 - 9.9	
1829	1463	1097	549	2640 - 3170	11.7 - 9.8	
2032	1626	1219	610	2930 - 3520	11.8 - 9.8	
2134	1707	1280	640	3080 - 3700	11.7 - 9.8	
2286	1829	1372	686	3310 - 3970	11.7 - 9.8	
2540	2032	1524	762	3680 - 4410	11.7 - 9.8	
3048	2438	1829	914	4420 - 5300	11.7 - 9.8	
3810	3048	2286	1143	5540 - 6640	11.7 - 9.8	
4572	3658	2743	1372	6650 - 7980	11.7 - 9.8	
5080	4064	3048	1524	7400 - 8870	11.6 - 9.7	
5588	4470	3353	1676	8140 - 9760	11.6 - 9.7	
6096	4877	3658	1829	8890 - 10650	11.6 - 9.7	
6604	5283	3962	1981	9630 - 11540	11.6 - 9.7	
7112	5690	4267	2134	10370 - 12430	11.6 - 9.7	
7620	6096	4572	2286	11120 - 13320	11.6 - 9.7	

WARNING

- * Installing your projector on the ceiling must be done by a qualified technician. Contact your dealer for more information.
- * Do not attempt to install the projector yourself.
- Only use your projector on a solid, level surface. If the projector falls to the ground, you can be injured and the projector severely damaged.
- Do not use the projector where temperatures vary greatly. The projector must be used at temperatures between 41°F (5°C) and 104°F (40°C). (Eco mode selected automatically at 95°F to 104°F/35°C to 40°C)
- Do not expose the projector to moisture, dust, or smoke. This will harm the screen image.
- Ensure that you have adequate ventilation around your projector so heat can dissipate. Do not cover the vents on the side or the front of the projector.

Reflecting the Image

Using a mirror to reflect your projector's image enables you to enjoy a much larger image when a smaller space is required. Contact your dealer if you need a mirror system. If you're using a mirror system and your image is inverted, use the MENU and SELECT buttons on your projector cabinet or your remote control to correct the orientation. (→ page 41)

② Making Connections

Connecting Your PC or Macintosh Computer

NOTE: When using with a notebook PC, be sure to connect the projector and notebook PC while the projector is in standby mode and before turning on the power to the notebook PC.

In most cases the output signal from the notebook PC is not turned on unless connected to the projector before being powered up.

** If the screen goes blank while using your remote control, it may be the result of the computer's screen-saver or power management software.*

Enabling the computer's external display

Displaying an image on the notebook PC's screen does not necessarily mean it outputs a signal to the projector.

When using a PC compatible laptop, a combination of function keys will enable/disable the external display.

Usually, the combination of the 'Fn' key along with one of the 12 function keys gets the external display to come on or off. For example, NEC laptops use Fn + F3, while Dell laptops use Fn + F8 key combinations to toggle through external display selections.

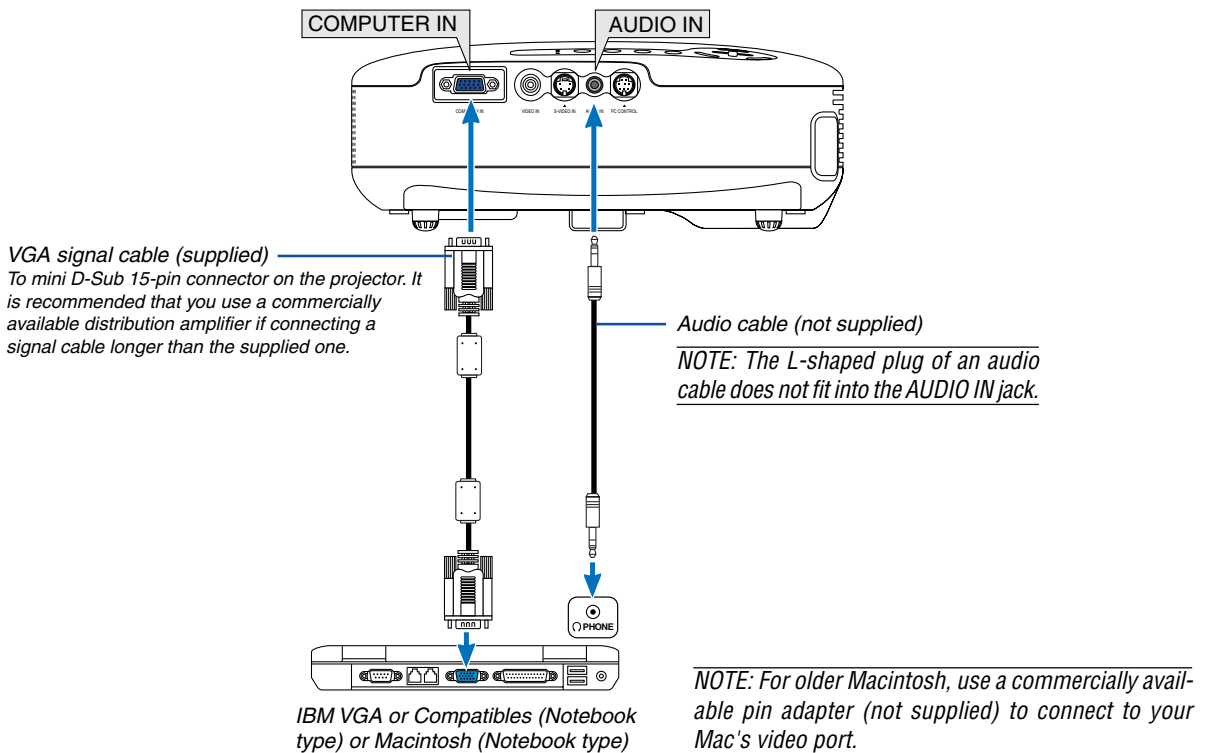

NOTE: The projector is not compatible with video decoded outputs of either the NEC ISS-6020 and ISS-6010 switchers.

NOTE: An image may not be displayed correctly when a Video or S-Video source is played back via a commercially available scan converter.

This is because the projector will process a video signal as a computer signal at the default setting. In that case, do the following.

** When an image is displayed with the lower and upper black portion of the screen or a dark image is not displayed correctly:*

Project an image to fill the screen and then press the AUTO ADJ button on the remote control or the projector cabinet.

To connect SCART output (RGB)

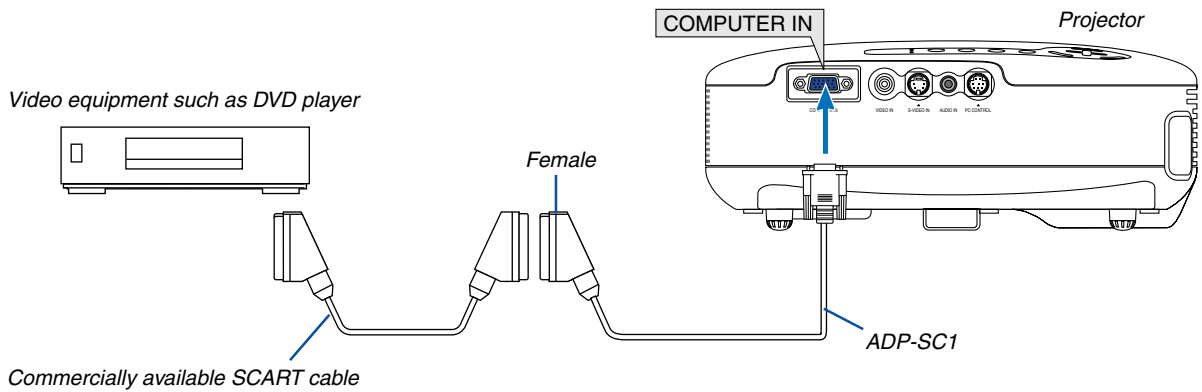

Before connections: An exclusive SCART adapter (ADP-SC1) and a commercially available SCART cable are required for this connection.

From the menu, select [Setup - Options] → [Signal Select] → [Computer] → [Scart].

SCART is a standard European audio-visual connector for TVs, VCRs and DVD players. It is also referred to as Euro-connector.

NOTE: Audio signal is not available for this connection.

TIP: The ADP-SC1 SCART adapter is obtainable from your dealer in Europe.

Connecting Your DVD Player with Component Output

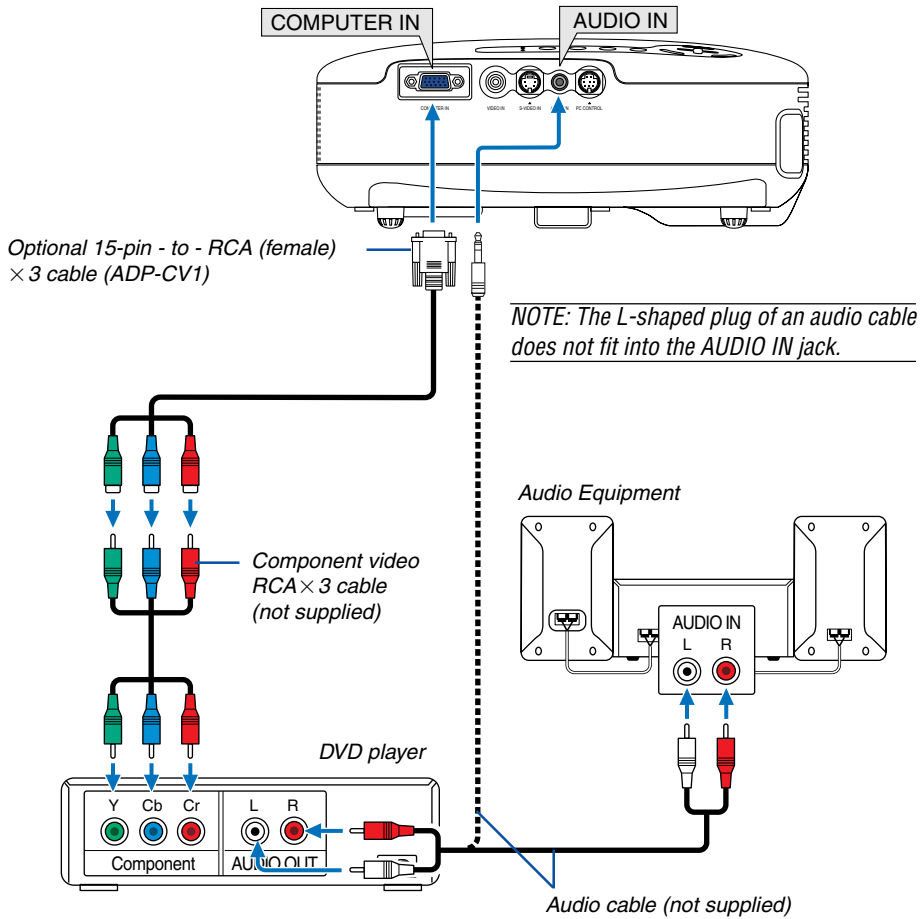

A component signal will be automatically displayed. If not, from the menu, select [Setup - Options] → [Signal Select] → [Computer], and then place a check mark in the “RGB/Component” radio button.

NOTE: Refer to your DVD player's owner's manual for more information about your DVD player's video output requirements.

Connecting Your VCR or Laser Disc Player

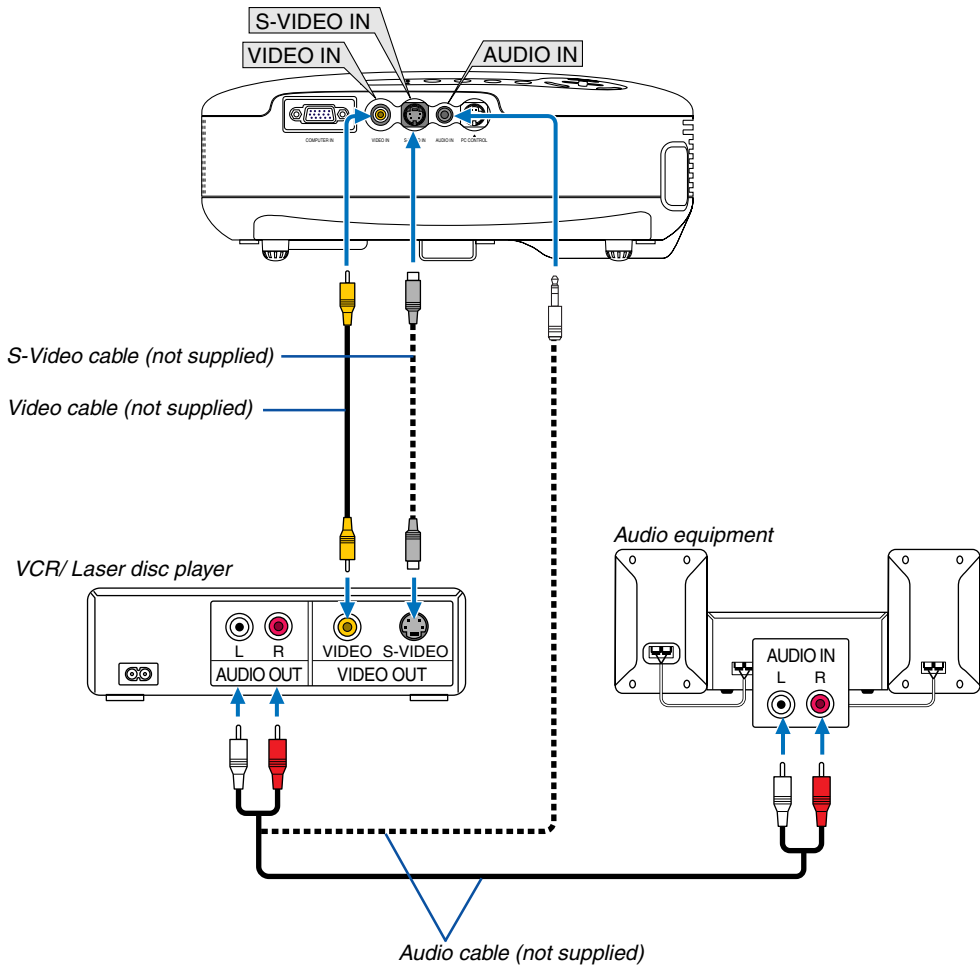

NOTE: Refer to your VCR or laser disc player owner's manual for more information about your equipment's video output requirements.

NOTE:

- An image may not be displayed correctly when a Video or S-Video source is played back in fast-forward or fast-rewind via a scan converter.
- The AUDIO IN mini jack is shared between VIDEO IN/S-VIDEO IN and COMPUTER IN.

Connecting the Supplied Power Cable

Connect the supplied power cable to the projector.

First connect the supplied power cable's three-pin plug to the AC IN of the projector, and then connect the other plug of the supplied power cable in the wall outlet.

The projector will go into its standby mode and the power indicator will glow orange.

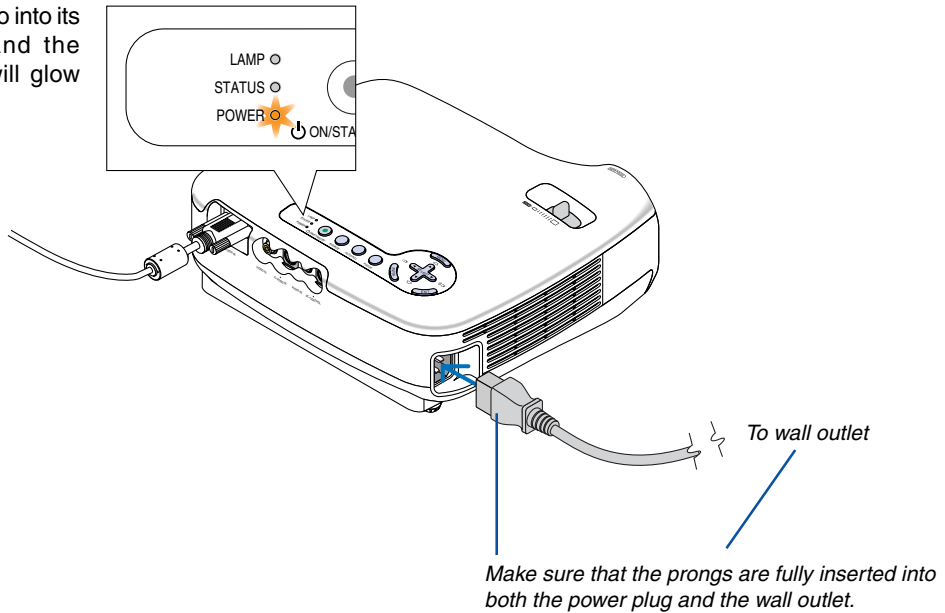

CAUTION:

Do not try to touch the ventilation outlet on the right front (when seen from the front) as it can become heated while the projector is turned on and immediately after the projector is turned off.

CAUTION:

Do not unplug the power cable from the wall outlet or projector when the project is powered on. Doing so can cause damage to the AC IN connector of the projector and (or) the prong plug of the power cable.

TIP: To turn off the AC power supply when the projector is powered on, use a power strip equipped with a switch and a breaker.

TIP: The projector can be unplugged during its cool down period after it is turned off.

3. Projecting an Image (Basic Operation)

This section describes how to turn on the projector and to project a picture onto the screen.

1 Turning on the Projector

NOTE: Before turning on the projector, first connect the supplied power cable's three-pin plug to the AC IN of the projector, and then connect the other plug of the supplied power cable in the wall outlet. Make sure that the projector is in its standby mode and the power indicator is glowing orange.

1. Remove the lens cap.

CAUTION:

Do not remove the lens cap by pulling on the string. Doing so can cause mechanical damage to the part around the lens.

2. Press the **POWER (ON/STAND BY)** button on the projector cabinet or the **POWER ON** button on the remote control for 1 second.

The **POWER** indicator will turn to green and the projector will become ready to use.

TIP:

- * Turning on the projector will instantly cause the Auto Focus function to operate. (→ page 22)
- * When the key lock symbol () is displayed at the bottom right of the menu, it means that the Control Panel Lock is turned on. (→ page 41)

After you turn on your projector, ensure that the computer or video source is turned on and that your lens cap is removed.

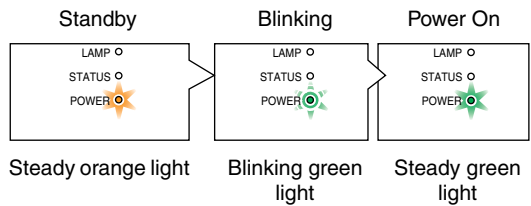
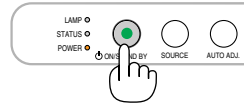

See page 50 for more details.

NOTE: When no signal is available, a blue or black screen is displayed.

When the projector displays a blue or black screen, the projector will automatically switch to the Eco mode.

The projector will return to the Normal mode once a signal is connected.

NOTE: If you turn on the projector immediately after the lamp is turned off or when the temperature is high, the fans run without displaying an image for some time and then the projector will display the image.

CAUTION:

The projector cannot be turned off for 60 seconds after the lamp is turned on and while the **POWER** indicator is blinking green.

- Do not turn off the AC power during this period. Doing so could cause premature lamp failure.

3. Projecting an Image (Basic Operation)

Note on Startup screen (Menu Language Select screen)

When you first turn on the projector, you will get the Startup menu. This menu gives you the opportunity to select one of the nine menu languages.

To select a menu language, follow these steps:

1. Use the **SELECT ▲ or ▼** button to select one of the nine languages from the menu.

Menu Language Select	
Please select a menu language.	English
Wählen Sie bitte die Menü Sprache aus.	Deutsch
S'il vous plaît choisir la langue de menu.	Français
Per favore di scegliere la lingua di menu.	Italiano
Escoja por favor el idioma de menú.	Español
Välj menyn språken.	Svenska
メニュー言語を選択してください。	日本語
请选择菜单语言	中文
메뉴 언어를 선택하여 주십시오.	한국어

Select "UP", "DOWN" & "ENTER"

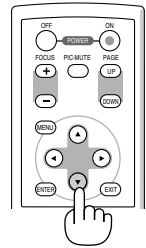
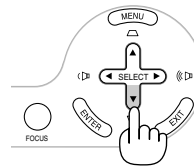

2. Press the **ENTER** button to execute the selection.

After this has been done, you can proceed to the menu operation.

If you want, you can select the menu language later. (→ [Language] on page 40)

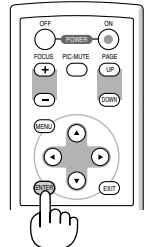
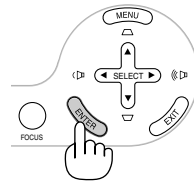

NOTE: Immediately after turning on the projector, screen flicker may occur. This is normal. Wait 3 to 5 minutes until the lamp lighting is stabilized.

When the [Lamp mode] is set to [Eco], the LAMP indicator will light green.

If one of the following things happens, the projector will not turn on.

- If the internal temperature of the projector is too high, the projector detects abnormal high temperature. In this condition the projector will not turn on to protect the internal system. If this happens, wait for the projector's internal components to cool down.
- When the lamp reaches its end of usable life, the projector will not turn on. If this happens, replace the lamp.
- If the lamp fails to light, and if the STATUS indicator flashes on and off in a cycle of six times, wait a full minute and then turn on the power.

2 Selecting a Source

Selecting the computer or video source

NOTE: Turn on the computer or VCR connected to the projector.

Selecting a source from the Source list

Press and quickly release the SOURCE button on the projector cabinet to display the Source list. Each time the SOURCE button is pressed, each source name will be highlighted in sequence.

Press the ENTER button or allow 2 seconds to elapse.

The selected signal will be displayed.

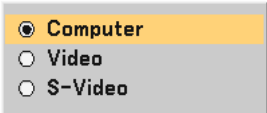

Detecting the Signal Automatically

Press and hold the SOURCE button for a minimum of 2 seconds, the projector will search for the next available input source.

Using the Remote Control

Press any one of the VIDEO, S-VIDEO and COMPUTER buttons.

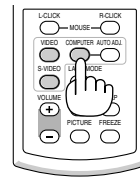
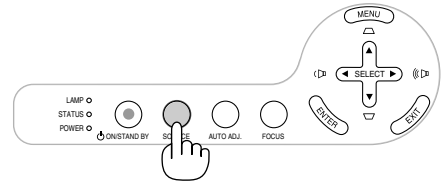

③ Adjusting the Picture Size and Position

Place your projector on a flat level surface and ensure that the projector is square to the screen.

Lift the front edge of the projector to center the image vertically.

* If the projected image does not appear square to the screen then use the Keystone feature for proper adjustment. (→ page 25)

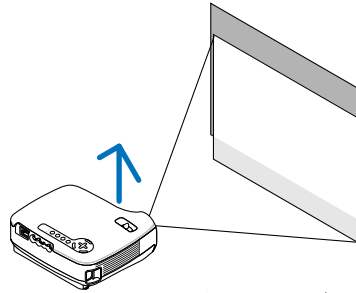

About Auto Focus

Just placing the projector on a flat level surface makes a focused image. (→ page 22)

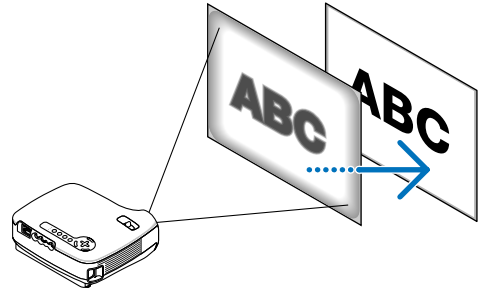

About Auto Keystone Correction

Adjusting the height of a projected image or changing the projection angle will result in the Auto Keystone function to work to quickly correct the vertical distortion. (→ page 23)

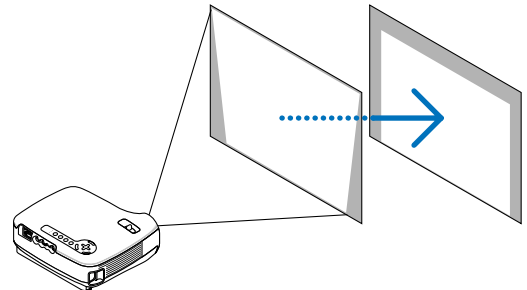

Move the projector left to center the image horizontally on the screen.

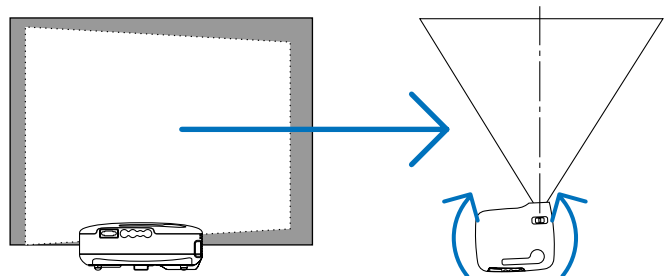

3. Projecting an Image (Basic Operation)

Adjust the Tilt Foot

1. Lift the front edge of the projector.

⚠ CAUTION:

Do not try to touch the ventilation outlet during Tilt Foot adjustment as it can become heated while the projector is turned on and during its cool down period after it is turned off.

2. Push and hold the Adjustable Tilt Foot Button on the front of the projector to extend the adjustable tilt foot (maximum height).

3. Lower the front of the projector to the desired height.

4. Release the Adjustable Tilt Foot Button to lock the adjustable tilt foot.

There is approximately 10 degrees (up) of adjustment for the front of the projector.

Adjusting the height of a projected image or changing projection angle will result in Auto Keystone function to work to quickly correct the vertical distortion. The "Keystone" screen will be displayed.

For operating the "Keystone" screen, see "Correcting Keystone Distortion" on page 25.

⚠ CAUTION:

Do not use the tilt-foot for purposes other than originally intended. Misuses such as using the tilt foot to carry or hang (from the wall or ceiling) the projector can cause damage to the projector.

NOTE: The rear foot height can be adjusted up to 0.1 inch/3 mm (1 degree of angle). Rotate the rear foot to the desired height in order to square the image on the projection surface, but the vertical distance from the bottom to the desk or floor should be 0.1" (3 mm) to make the projector horizontal on the flat surface.

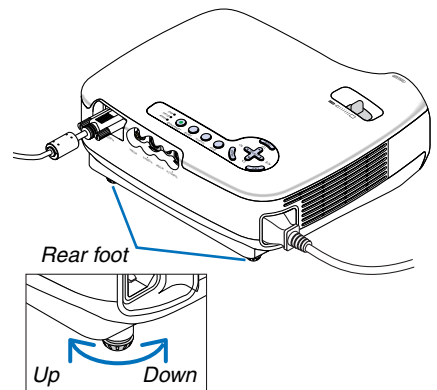
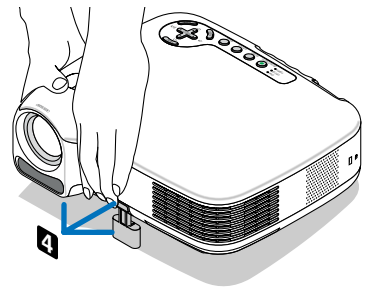
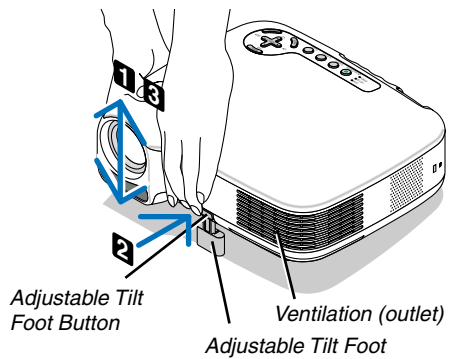
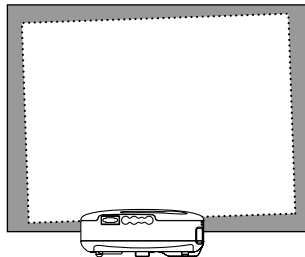

3. Projecting an Image (Basic Operation)

Zoom

Use the ZOOM lever to adjust the image size on the screen.

NOTE: Rotating the ZOOM lever will cause the focus to be adjusted automatically.

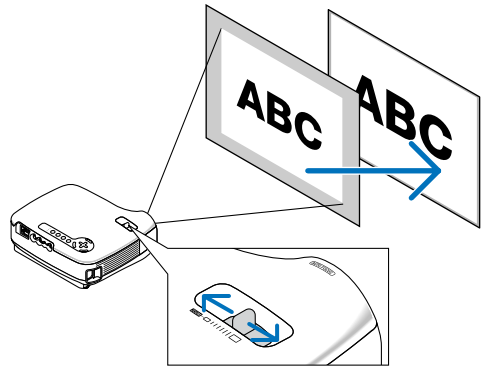

Auto Focus

The focus sensor on the projector detects the distance to the screen and automatically adjusts the focus of an image.

- The Auto Focus function will work when the following tasks are done:
 - Turning on the power
 - Changing the zoom lever
 - Repositioning the projector
 - Changing the projection angle

Effective auto focus range for screen 4:3

Throw distance		Image size (inch)	
		Tele (Zoom at min.)	Wide (Zoom at max.)
Minimum distance	55.1"/1.4 m	32"	39"
Maximum distance	216.5"/5.5 m	124"	149"

When the throw distance is beyond 5.5 m/216.5", it means that the focus sensor will not work correctly and that you need to use the FOCUS button to adjust the focus manually.

NOTE: In some cases, the Auto Focus may not work correctly or the Auto Focus range can be made narrower, depending on the environmental conditions.

The Auto Focus function will not work under the following circumstances

- When using a transparent screen.
- When there are objects between the focus sensor of the projector and the screen.
- When moving the projector so slowly that the focus sensor cannot detect the distance to the screen.
- When moving the screen, not the projector, because the focus sensor cannot detect the distance to the screen

TIP: To turn off the Auto Focus function, from the menu select [Setup - Options] → [Auto Focus] and select [Off].

3. Projecting an Image (Basic Operation)

Auto Keystone Correction

The Auto Keystone correction feature will correct the vertical distortion of a projected image on the screen. No special operation required. Just place the projector on a flat surface.



NOTE: When using the Auto Keystone function, heed the following:

- The vertical keystone angle can be corrected between 16 degrees upward and 16 degrees downward from level.
- The Auto Keystone correction will take effect in 2 seconds after changing the projection angle during projection.
- The left and right, or horizontal keystone distortion is not available.

Place the projector so that the lens surface is parallel to the screen.
Also, adjust the height to keep the projector level by rotating the rear feet.

TIP: To turn off the Auto Keystone function, from the menu select [Setup - General] → [Auto Keystone] and select [Off]. (→ page 25)
Even when the menu setting for [Auto Keystone] is turned on, [Keystone] can be adjusted manually.

NOTE: Auto and Manual Keystone correction angle could be less than 16 degrees depending on some kinds of signal and aspect ratios.

NOTE: The Auto Keystone Correction feature can cause an image to be slightly blurred because the correction is made electronically.

4 Adjusting Focus Manually

Adjust the focus manually in the following cases:

- When adjusting the focus out of the effective range of the automatic focus
- When finely adjusting the focus
- When the menu setting for [Auto Focus] is turned off

Adjusting with buttons on the cabinet

1. Press the **FOCUS** button quickly.

The focus adjustment screen will be displayed.



The focus adjustment screen will be closed if no button operation is made for 5 seconds.

TIP: If the projector is placed within the effective focus range, pressing and holding the **FOCUS** for a minimum of 2 seconds starts the Auto Focus function.

2. Press the **SELECT** ◀ or ▶ button to adjust the focus.

3. Press the **EXIT** button.

The focus adjustment screen will be closed.

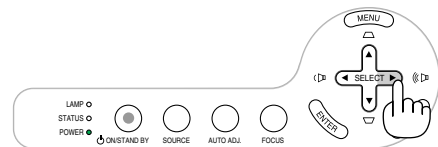
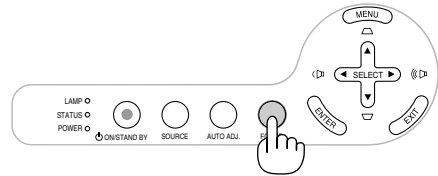

Adjusting with the remote control

1. Press the **FOCUS + or -** button.

The focus adjustment screen will be displayed.



- The focus adjustment screen will be closed if no button operation is made for 5 seconds.
- Use the **FOCUS + or -** button to adjust the focus.

2. Press the **EXIT** button.

The focus adjustment screen will be closed.

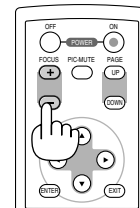

5 Correcting Keystone Distortion Manually

You can also correct the vertical keystone distortion manually.

NOTE: Manual keystone correction is not available when there is no signal received by any input.

Adjust the keystone distortion manually in the following cases:

- To fine tune Keystone correction even after performing the [Auto Keystone] adjustment.
- When the menu setting for [Auto Keystone] is turned off

Adjusting with buttons on the cabinet

1. Press the **SELECT** ▲ or ▼ button with no menus displayed.

The slide bar will be displayed for your adjustment.

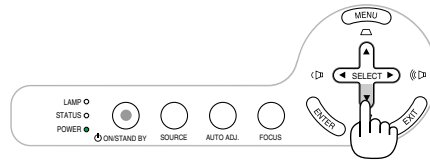

2. Press the **EXIT** button.

The slide bar will be closed.



Adjusting with the remote control

1. Press the **MENU** button.

The menu will be displayed.

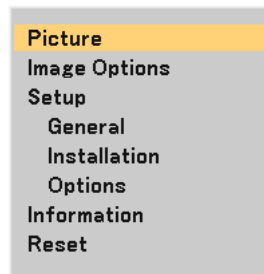

2. Use the **SELECT** ▼ button to select [Setup - General] and then press the **ENTER** button.

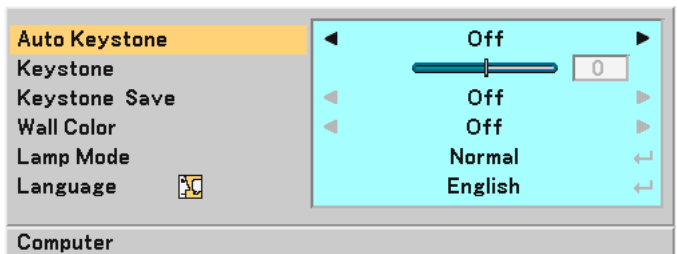

3. Select the **Keystone** function.

Use the **SELECT** ▼ button to select [Keystone].

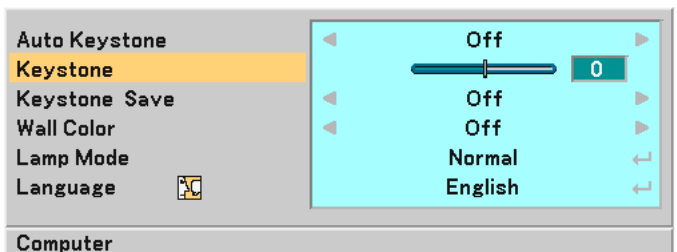

3. Projecting an Image (Basic Operation)

4. Correct the vertical distortion.

Use the **SELECT** ◀ or ▶ button to correct the vertical keystone distortion.

NOTE: The Keystone Correction feature can cause an image to be slightly blurred because the correction is made electronically.

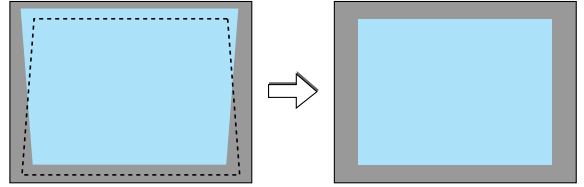

5. Press the **EXIT** button twice to close the menu.

TIP: You can save the changes using the Keystone Save feature when you turn off the projector. (→ page 40)

6 Optimizing RGB Picture Automatically

Adjusting the Image Using Auto Adjust

Optimizing an RGB image automatically.

Press the **AUTO ADJ.** button to optimize an RGB image automatically.

This adjustment may be necessary when you connect your computer for the first time.

[Poor picture]

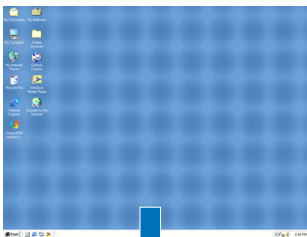

[Normal picture]

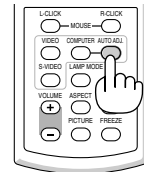
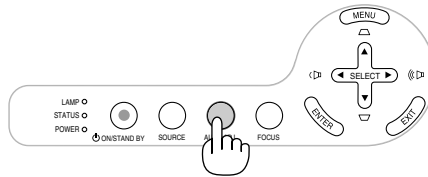
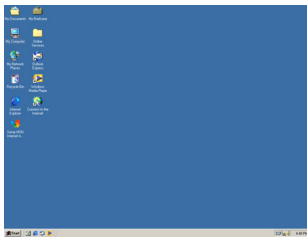

NOTE:

Some signals may take time to display or may not be displayed correctly.

- The Auto Adjust function does not work for component and video signals.
- If the Auto Adjust operation cannot optimize the RGB signal, try to adjust Horizontal/Vertical Position Clock and Phase manually. (→ page 39)

7 Adjusting Volume Up or Down

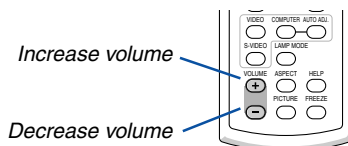

Sound level from the speaker can be adjusted.

*TIP: When no menus appear, the **SELECT** ◀ and ▶ buttons on the projector cabinet work as a volume control.*

8 Turning off the Projector

To turn off the projector:

First, press the **POWER (ON/STAND BY)** button on the projector cabinet or the **POWER OFF** button on the remote control. The “Power Off / Are you sure?” message will appear.

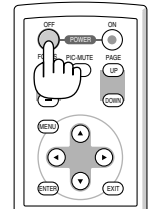
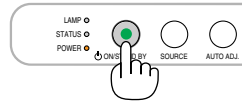
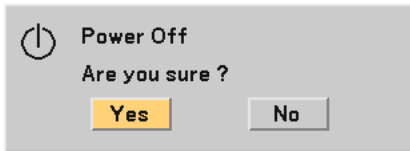

Secondly, press the **ENTER** button or press the **POWER (ON/STAND BY)** or the **POWER OFF** button again. The power indicator will glow orange.

Immediately after turning on the projector and displaying an image, you cannot turn off the projector for 60 seconds.

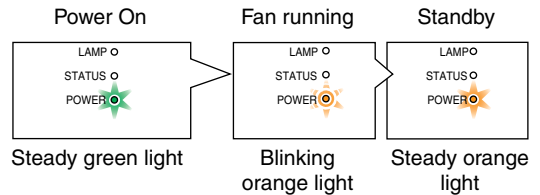

About Direct Power Off

The projector has a feature called "Direct Power Off". This feature allows the projector to be turned off (even when projecting an image) using a power strip equipped with a switch and a breaker.

NOTE: Do not turn off the projector using the "Direct Power Off" function within 10 seconds of making adjustment or setting changes and closing the menu.

Doing so can cause loss of adjustments and settings.

⚠ CAUTION:

Do not unplug the power cable from the wall outlet or projector when the projector is powered on. Doing so can cause damage to the AC IN connector of the projector and (or) the prong plug of the power cable.

TIP: To turn off the AC power supply when the projector is powered on, use a power strip equipped with a switch and a breaker.

TIP: The projector can be unplugged during its cool down period after it is turned off.

⚠ CAUTION:

Parts of the projector will become heated during operation. Use caution when picking up the projector immediately after it has been operating.

9 After Use

Preparation: Make sure that the projector is turned off.

1. **Unplug the power cable.**
2. **Disconnect any other cables.**
3. **Retract adjustable tilt foot if extended.**
4. **Cover the lens with the lens cap.**
5. **Put the projector and its accessories in the supplied soft case.**

⚠ CAUTION:

Use caution when putting the projector in the soft case immediately after the projector has been operating. The projector cabinet is hot.

4. Convenient Features

1 Turning off the Image and Sound

Press the PIC-MUTE button to turn off the image and sound for a short period of time. Press again to restore the image and sound.

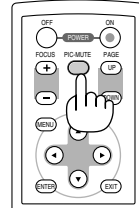

2 Freezing a Picture

Press the FREEZE button to freeze a picture. Press again to resume motion.

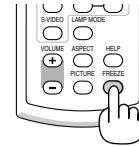

3 Changing Lamp Mode

The lamp life can be extended by using the Eco mode.

To change to the “Eco” mode, do the following:

1. Press the LAMP MODE button to display [Lamp Mode] screen.
2. Use the SELECT ▲ or ▼ button to select [Eco] mode.
3. Press the ENTER button. Or press the SELECT ► button to select [OK] and press the ENTER button.

To cancel it, select [Cancel] and press the ENTER button.

To change from [Eco] to [Normal], Go back to Step 2 and select [Normal]. Repeat Step 3.

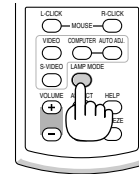

Normal Mode This is the default setting (100% Brightness).

Eco Mode Select this mode to increase the lamp life and reduce fan noise (LT35: 77% Brightness, LT30/LT25: 85% Brightness).

4 Preventing the Unauthorized Use of the Projector

A keyword can be set for your projector using the Menu to avoid operation by an unauthorized user. When a keyword is set, turning on the projector will display the Keyword input screen. Unless the correct keyword is entered, the projector cannot project an image.

To enable the Security function:

1. Press the MENU button.
The menu will be displayed.
2. Use SELECT ▲ or ▼ button to select [Setup - Installation] → [Security] and press the ENTER button.

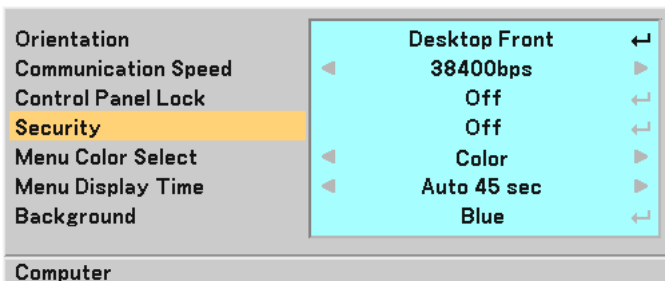

The Off/On menu will be displayed.

3. Select [On] and press the ENTER button.



The [Keyword] screen will be displayed.

4. Type in a combination of the four SELECT ▲▼◀▶ buttons and press the ENTER button.

NOTE: A keyword must be four to 10 digits in length.



The [Confirm Keyword] screen will be displayed.

5. Type in the same combination of SELECT ▲▼◀▶ buttons and press the ENTER button.



The confirmation screen will be displayed.

6. Select [Yes] and press the ENTER button.

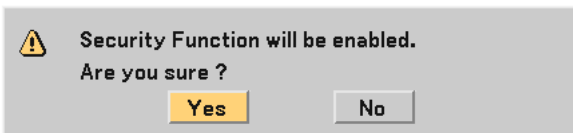

The Security function has been enabled.

To turn on the projector when [Security] is enabled:

When the Security function is enabled and the projector is turned on, the projector will display a blue background.

To display an image at this time, press the MENU button to display the Keyword input screen.



Type in the correct keyword and press the ENTER button. The projector will display an image.

NOTE: The security disable mode is maintained until the main power is turned off or unplugging the power cable.

To disable the Security function:

1. Press the MENU button.

The menu will be displayed.

2. Select [Setup - Installation] → [Security] and press the ENTER button.

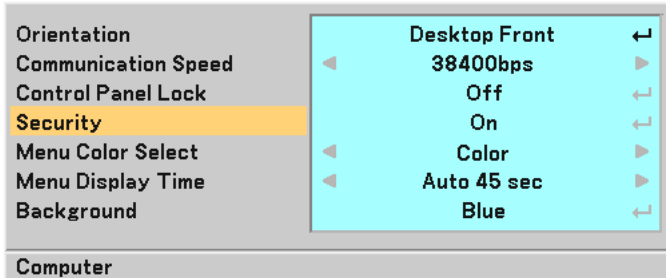

The Off/On menu will be displayed.

3. Select [Off] and press the ENTER button.

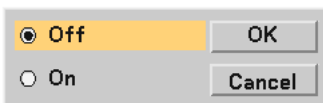

The Keyword confirmation screen will be displayed.

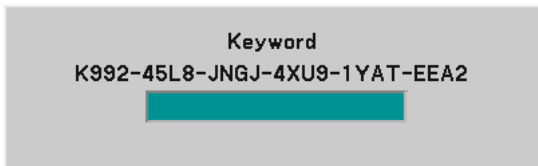

4. Type in your keyword and press the ENTER button.

When the correct keyword is entered, the Security function will be disabled.

NOTE: If you forget your keyword, contact your dealer. Your dealer will provide you with your keyword in exchange for your request code. Your request code is displayed in the Keyword Confirmation screen. In this example [K992-45L8-JNGJ-4XU9-1YAT-EEA2] is a request code.

5 Using the Optional Remote Mouse Receiver

The optional remote mouse receiver enables you to operate your computer's mouse functions from the remote control. It is a great convenience for clicking through your computer-generated presentations.

Connecting the remote mouse receiver to your computer

If you wish to use the remote mouse function, connect the mouse receiver and computer. The mouse receiver can be connected directly to the computer's USB port (type A).

NOTE: Depending on the type of connection or OS installed on your computer, you may have to restart your computer or change your computer settings.

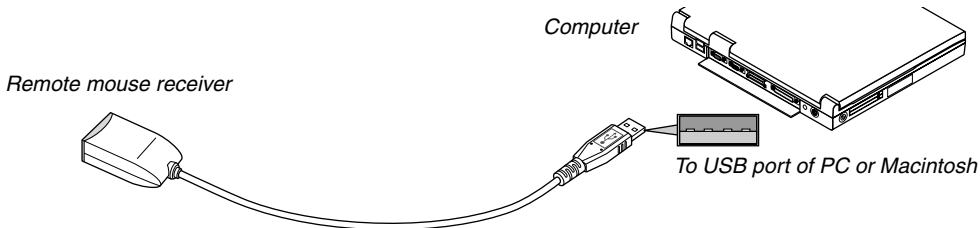

When operating a computer via the remote mouse receiver

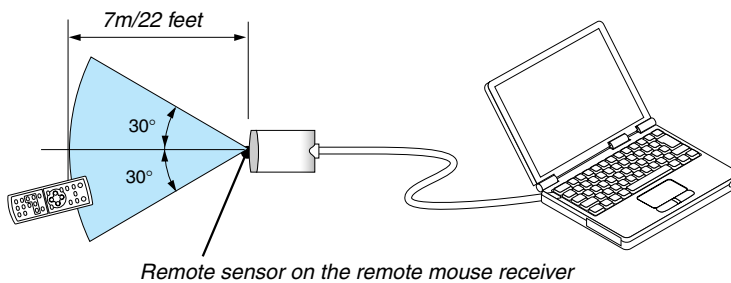

When connecting using the USB terminal

For PC, the mouse receiver can only be used with a Windows 98/Me/XP*, Windows 2000 or Mac OS X 10.0.0 or later operating system.

** NOTE: In Windows XP, if the mouse cursor will not move correctly, do the following: Clear the Enhance pointer precision check box underneath the mouse speed slider in the Mouse Properties dialog box [Pointer Options tab].*

NOTE: Wait at least 5 seconds after disconnecting the mouse receiver before reconnecting it and vice versa. The computer may not identify the mouse receiver if it is repeatedly connected and disconnected in rapid intervals.

Operating your computer's mouse from the remote control

You can operate your computer's mouse from the remote control.

PAGE UP/DOWN Button scrolls the viewing area of the window or to move to the previous or next slide in PowerPoint on your computer.

SELECT ▲▼◀▶ Buttons .. moves the mouse cursor on your computer.

MOUSE L-CLICK Button works as the mouse left button.

MOUSE R-CLICK Button works as the mouse right button.

NOTE: When you operate the computer using the SELECT ▲▼◀ or ▶ button with the menu displayed, both the menu and the mouse pointer will be affected. Close the menu and perform the mouse operation.

TIP: You can change the Pointer speed on the Mouse Properties dialog box on the Windows. For more information, see the user documentation or online help supplied with your computer.

5. Using On-Screen Menu

① Using the Menus

NOTE: The on-screen menu may not be displayed correctly while an interlaced motion video image is projected.

1. Press the **MENU** button on the remote control or projector cabinet to display the main menu.

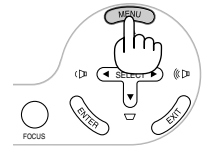
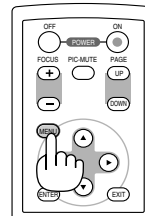
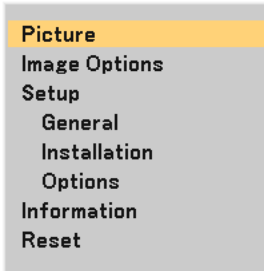

2. Press the **SELECT ▲▼** buttons on the remote control or the projector cabinet to highlight the menu for the item you want to adjust or set.

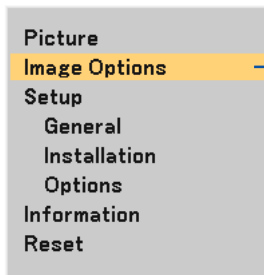

Highlight
Indicates the selected menu
or item.

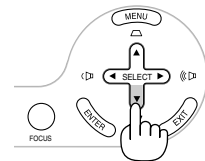
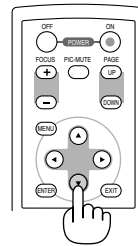

3. Press the **ENTER** button on the remote control or the projector cabinet to select a submenu or item.

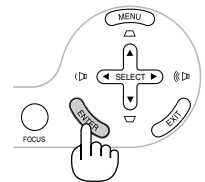
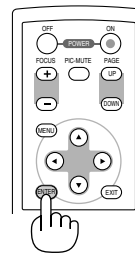
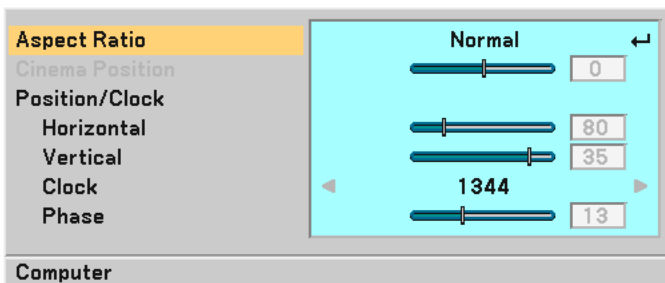

4. Use the **SELECT ▲▼** buttons on the remote control or the projector cabinet to select the item you want to adjust or set.

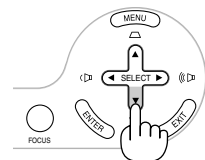
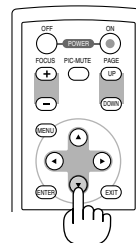

5. Adjusting the level of a selected item or selecting an item.

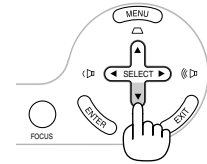
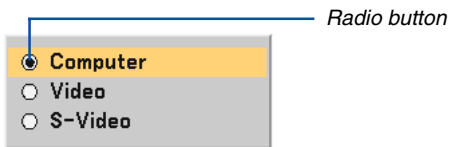
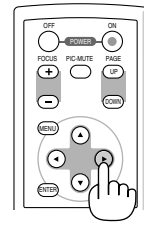
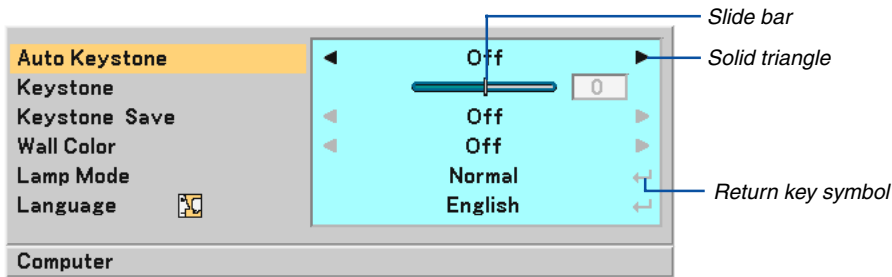

For Adjusting items (Slide bar)

Slide bar Indicates settings or the direction of adjustment.

- Use the SELECT ◀▶ buttons to adjust the item.

For Selecting items (Solid triangle)

Solid triangle Indicates further choices are available. A highlighted triangle indicates the item is active.

- Use the SELECT ◀▶ buttons to select the item.

For Selecting items (Return key symbol, Radio button)

Return key symbol Indicates further choices are available.

Radio button Use this round button to select an option in a dialog box.

- 1) Press the ENTER button. The selected item will be displayed.
- 2) Use the SELECT ▲▼ buttons to highlight the item you want to set.

Changes are stored until you adjust it again.

Press the EXIT button to return to the previous screen.

6. Repeat steps 2-5 to adjust an additional item, or press the EXIT button several times to close the menu.

2 Menu Elements

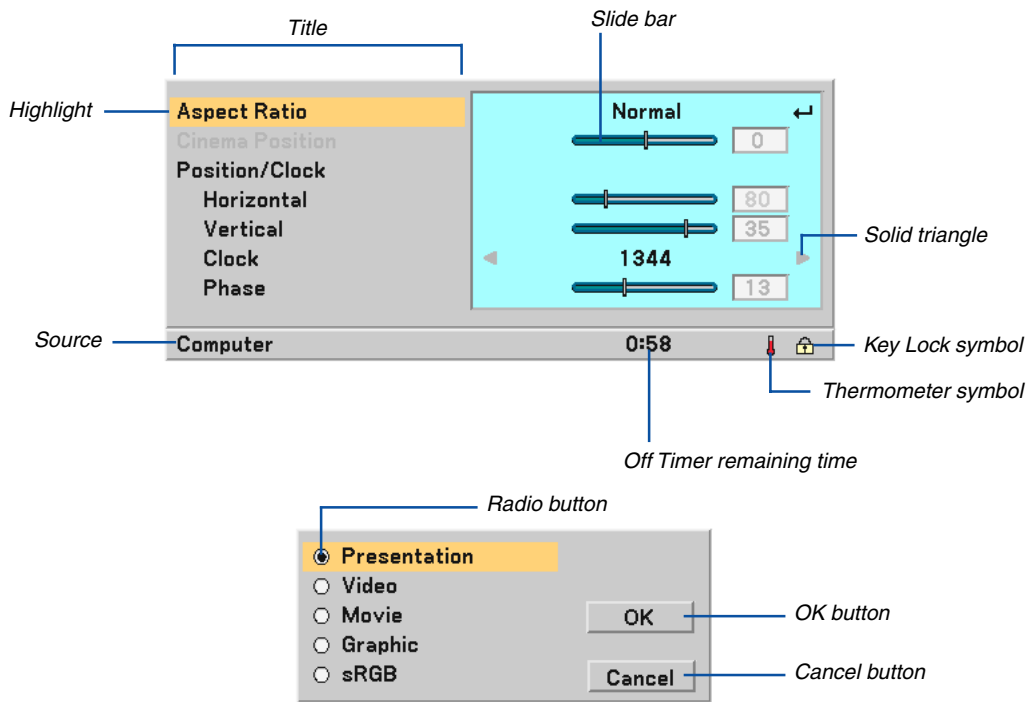

Menu windows or dialog boxes typically have the following elements:

- Title Indicates the menu title.
- Highlight Indicates the selected menu or item.
- Source Indicates the currently selected source.
- Off timer remaining time Indicates the remaining countdown time when the Off Timer is preset.
- Solid triangle Indicates further choices are available. A highlighted triangle indicates the item is active.
- Radio button Use this round button to select an option in a dialog box.
- Slide bar Indicates settings or the direction of adjustment.
- OK button Press to confirm your setting. You will return to the previous menu.
- Cancel button Press to cancel your setting. You will return to the previous menu.
- Key Lock symbol Indicates the Control Panel Lock is enabled.
- Thermometer symbol Indicates the lamp mode is forcibly set to Eco mode because the internal temperature is too high.

3 List of Menu Items

Some menu items are not available depending on the input source.

Picture		Default	Item	Resttable
Preset			1 to 5	
Detail Settings	Reference	*	Presentation, Video, Movie, Graphic, sRGB	
	Gamma Correction	*	Dynamic, Natural, Black Detail	Yes
	Color Temperature	*	5000, 6500, 7800, 8500, 9300, 10500	Yes
	White Peaking	*		Yes
Brightness				Yes
Contrast				Yes
Sharpness				Yes
Color				Yes
Hue				Yes
Reset				

Image Options		Default	Item	Resttable
Aspect Ratio		*	Normal, Cinema, Native	Yes
Cinema Position				Yes
Position/Clock	Horizontal	*		Yes
	Vertical	*		Yes
	Clock	*		Yes
	Phase	*		Yes
Noise Reduction		Off	Off, On	Yes
Telecine		Off	Off, Auto	Yes

Setup		Default	Item	Resttable	
General	Auto Keystone	On	Off, On	Yes	
	Keystone			Yes	
	Keystone Save	Off	Off, On	Yes	
	Wall Color	Off	Off, Blackboard, Blackboard(Gray), Light yellow, Light green, Light blue, Sky blue, Light rose, Pink	Yes	
	Lamp Mode	Normal	Normal, Eco	Yes	
	Language	English	English, Deutsch, Français, Italiano, Español, Svenska, 日本語, Dansk, Português, Čeština, Magyar, Polski, Nederlands, Suomi, Norsk, Türkçe, Русский, Ελληνικά, 中文, 한국어	-	
Installation	Orientation	Desktop Front	Desktop Front, Ceiling Rear, Desktop Rear, Ceiling Front	Yes	
	Communication Speed	38400bps	4800bps/9600bps/19200bps/38400bps	-	
	Control Panel Lock	Off	Off, On	Yes	
	Security	Off	Off, On	-	
	Menu Color Select	Color	Color, Monochrome	Yes	
	Menu Display Time	Auto 45 sec	Manual/Auto 5 sec/Auto 15sec/Auto 45 sec	Yes	
	Background	Blue	Blue, Black	-	
Options	Off Timer	Off	Off/0:30/1:00/2:00/4:00/8:00/12:00/16:00	Yes	
	Auto Focus	On	Off, On	Yes	
	Auto Start	Off	Off, On, Last	Yes	
	Power Management	Off	Off/0:05/0:10/0:20/0:30	Yes	
	Fan Mode	Auto	Auto, High	Yes	
	Signal Select	Computer	RGB/Component	RGB/Component, Scart	Yes
		Video	Auto	Auto, NTSC3.58, NTSC4.43, PAL, PAL-M, PAL-N, PAL60, SECAM	Yes
		S-Video	Auto	Auto, NTSC3.58, NTSC4.43, PAL, PAL-M, PAL-N, PAL60, SECAM	Yes

* The asterisk (*) indicates that the default setting varies depending on the signal.

5. Using On-Screen Menu

Information		Item
Usage Time	Lamp Life Remaining	
	Lamp Hours Used	
	Projector Hours Used	
Source	Horizontal Frequency	
	Vertical Frequency	
	Video Type	NTSC, NTSC3.58, NTSC4.43, PAL, PAL-M, PAL-N, PAL60, SECAM
	Sync Type	Separate Sync, Composite Sync, G-Sync
	Sync Polarity	
Version	Scan Type	Interlace, Non-Interlace
	Firmware Data	

Reset		Item
	Current Signal	
	All Data	
	Clear Lamp Hours	

④ Menu Descriptions & Functions [Picture]

Preset

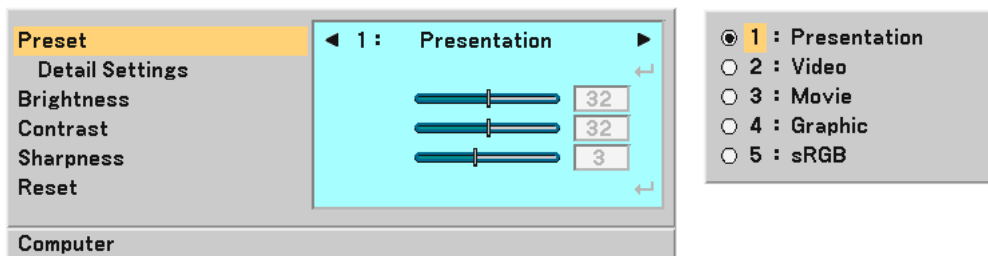

When selecting user adjustable presetting (Preset), the submenu will be displayed.

You can customize each gamma or color. To do so, first select [Preset] and press the ENTER button, and then proceed with the following steps.

Detail Settings



Selecting Reference Setting [Reference]

This option allows you to select one of 5 user adjustable presettings. There are 5 factory presets optimized for various types of images, you can set user adjustable settings.

Presentation Recommended for making a presentation using a PowerPoint file.

Video Recommended for standard video such as a TV program.

Movie Recommended for film based video such as a movie (DVD or HDTV).

Graphic Recommended for viewing accurate colors in graphics.

sRGB Standard color values.

Selecting Gamma Correction Mode [Gamma Correction]

Each mode is recommended for:

Dynamic Creates a high-contrast picture.

Natural Natural reproduction of the picture.

Black Detail Emphasizes detail in dark areas of the picture.

Adjusting Color Temperature [Color Temperature]

This option allows you to adjust the color temperature using the slide bar.

Move the slide bar to the right to increase color temperature (more blue); to the left to decrease color temperature (more red): 5000, 6500, 7800, 8500, 9300, 10500K.

NOTE:

- When [Presentation] is selected in [Reference], [Color Temperature] is not available.
- When color options other than [Off] is selected in [Wall Color], [Color Temperature] is not available.
- The adjustable range may vary depending on White Peaking adjustment.

Adjusting White Peaking [White Peaking]

This allows you to adjust the drive level of the white areas. As the picture becomes dim, it looks more natural.

NOTE:

- When [Presentation] is selected in [Reference], [White Peaking] is not available.
- When this option is highlighted, pressing the ENTER button will display its slide bar for adjustment.

Adjusting Brightness, Contrast, Sharpness, Color and Hue

You can adjust brightness, contrast, sharpness, color and hue.

TIP: When one of Brightness, Contrast, Sharpness, Color or Hue is highlighted, pressing the ENTER button will display its slide bar for adjustment.

- Brightness Adjusts the brightness level or the black level of the image.
- Contrast Adjusts the intensity of the image according to the incoming signal (White level of the image).
- Sharpness Controls the detail of the image for Video.
- Color Increases or decreases the color saturation level (not valid for RGB).
- Hue Varies the color level from +/- green to +/-blue. The red level is used as reference. This adjustment is only valid for Video and Component inputs (not valid for RGB).

Reset

The Reset feature allows you to change adjustments to the reference data you select.

5 Menu Descriptions & Functions [Image Options]



Selecting Aspect Ratio [Aspect Ratio]

Aspect Ratio allows you to select the best Aspect mode to display your source image.

You can also display the Aspect Ratio window by pressing the ASPECT button on the remote control. (→ page 7)

When 4:3 is selected from the source (i.e. DVD player), the following selections will display:

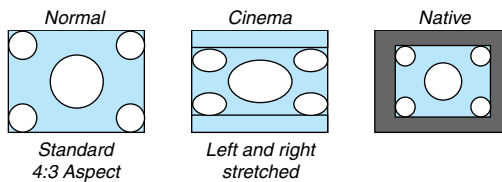

Standard 4:3 Aspect

Left and right stretched

When 16:9 is selected from the source (i.e. DVD player), the following selections will display:

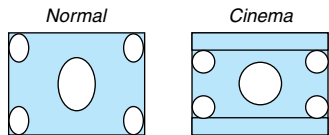

16:9 image displayed in 4:3 mode

Left and right stretched to display the true aspect

Native (RGB only): Turns off the scaling feature. The projector displays the current image in its true resolution.

NOTE:

- When you are displaying an RGB image with a higher resolution than the projector's native resolution, the image will be displayed in [Normal] even if [Native] is selected.
Only when displaying an RGB image with a lower resolution than the projector's native resolution, will the image be able to be displayed in its true resolution [Native].
- When [Normal] is selected, an HDTV (1080i/720p) signal will be shown in its true aspect, as is the case when selecting [Cinema].
- You can adjust the image position for Cinema aspect. See [Cinema Position] for setting the image position.

Copyright

Please note that using this projector for the purpose of commercial gain or the attraction of public attention in a venue such as a coffee shop or hotel and employing compression or expansion of the screen image with a [Aspect Ratio] setting may raise concern about the infringement of copyrights which are protected by copyright law.

Adjusting the Vertical Position of Image [Cinema Position] (for Cinema only)

This feature adjusts the vertical position of the image when viewing video with Cinema aspect ratio selected. When [Cinema] is selected in [Aspect Ratio], the image is displayed with black borders on the top and bottom. You can adjust the vertical position between top and bottom.

NOTE: This option is available only when "Cinema" is selected in Aspect Ratio.

Adjusting Horizontal/Vertical Position, Clock and Phase [Position/Clock]

You can adjust the image manually for position and stability; [Horizontal], [Vertical], [Clock] and [Phase].

[Horizontal/Vertical]

Adjusts the image location horizontally and vertically.

[Clock] (available for RGB signal only)

Use this item to fine tune the computer image or to remove any vertical banding that might appear. This function adjusts the clock frequencies that eliminate the horizontal banding in the image. This adjustment may be necessary when you connect your computer for the first time.

[Phase] (available for RGB signal only)

Use this item to adjust the clock phase or to reduce video noise, dot interference or cross talk. (This is evident when part of your image appears to be shimmering.)

Use [Phase] only after the [Clock] is complete.

Turning on Noise Reduction [Noise Reduction]

Turn on or off the noise reduction feature. To reduce video noise, select On.

NOTE:

- This feature is not available for 480p, 576p, 720p, 1080i and RGB signals
 - Noise reduction set to off gives best image quality by way of higher bandwidth. Noise reduction set to on softens the image.
-

Setting Telecine Mode [Telecine]

Use 3:2 or 2:2 pull down correction to eliminate jitter and artifacts in video.

Auto For film source such as a DVD player.

Off For signals other than film sources.

NOTE: This feature is not available for 480p, 576p, 720p, 1080i and RGB signals

⑥ Menu Descriptions & Functions [Setup]

[Setup - General]

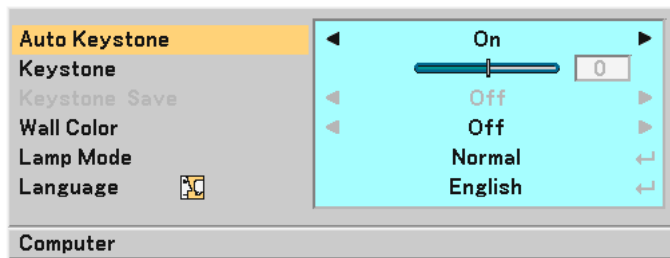

Enabling Auto Keystone [Auto Keystone]

This feature allows the projector to detect its tilt and correct vertical distortion automatically. Turn on the Auto Keystone feature, select "On".

Correcting Vertical Keystone Distortion Manually [Keystone]

You can correct vertical distortion manually. (→ page 25)

TIP: When this option is highlighted, pressing the ENTER button will display its slide bar for adjustment.

Saving Vertical Keystone Correction [Keystone Save]

This option enables you to save your current keystone settings.

Off Does not save current keystone correction settings

On Saves current keystone correction settings

Saving your change once affects all sources. The changes are saved when the projector is off.

NOTE: When [Auto Keystone] is set to [On], [Keystone Save] is not available. Next time you turn on the power, the Auto Keystone function will work and the data stored with [Keystone Save] will be invalid.

Selecting Wall Color Correction Mode [Wall Color]

This function allows for quick adaptive color correction in applications where the screen material is not white. The following 9 options are available: Off, Blackboard, Blackboard (Gray), Light yellow, Light green, Light blue, Sky blue, Light rose and Pink.

Selecting Lamp Mode [Lamp Mode]

This feature enables you to select two brightness modes of the lamp: Normal and Eco modes. The lamp life can be extended by using the Eco mode.

Normal Mode This is the default setting (100% Brightness).

Eco Mode Select this mode to increase the lamp life and reduce fan noise 85% Brightness.

Selecting Menu Language [Language]

You can choose one of 20 languages for the on-screen menu.

[Setup - Installation]

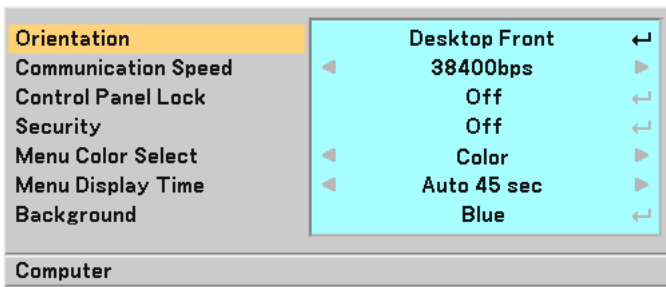

Selecting Projector Orientation [Orientation]

This sets your image for your type of projection application. The options are: desktop front projection, ceiling rear projection, desktop rear projection, and ceiling front projection.

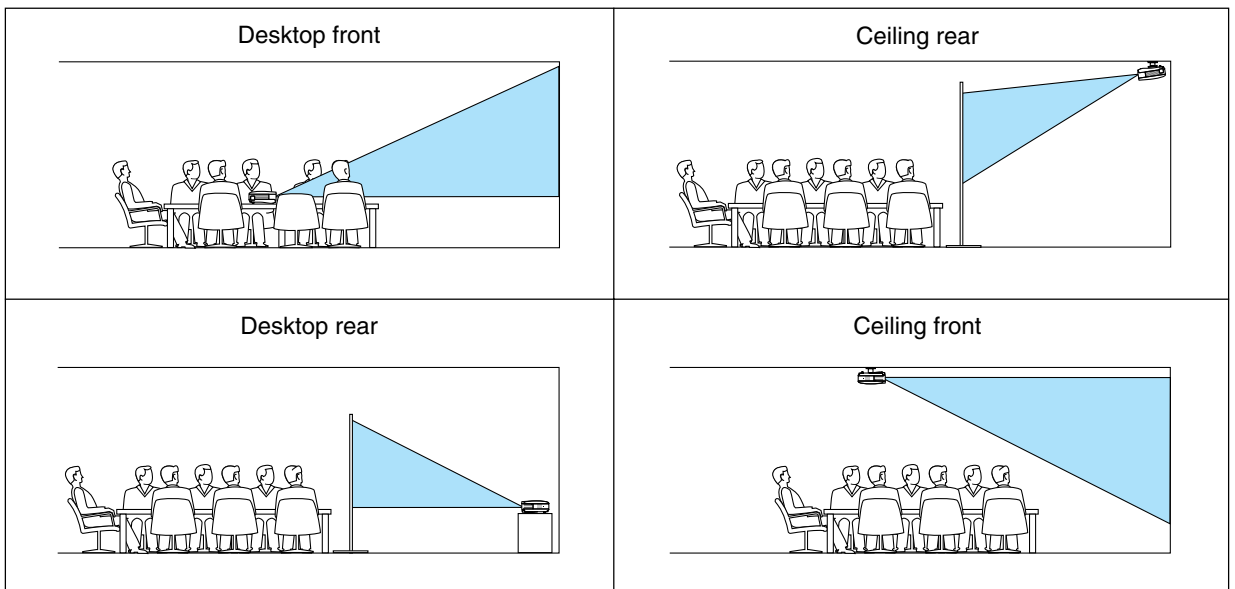

Selecting Communication Speed [Communication Speed]

This feature sets the baud rate of the PC Control port (Mini DIN 8 Pin). It supports data rates from 4800 to 38400 bps. The default is 38400 bps.

Select the appropriate baud rate for your equipment to be connected (depending on the equipment, a lower baud rate may be recommended for long cable runs).

Disabling the Cabinet Buttons [Control Panel Lock]

This option turns on or off the Key Lock function for cabinet buttons.

NOTE:

- The Control Panel Lock setting will not affect the remote control or PC Control Functions.
- When the cabinet buttons are disabled, pressing and holding the EXIT button for about 10 seconds will change the setting to enable.

Enabling Security [Security]

This feature turns on or off the Security function.

Unless the correct keyword is entered, the projector cannot project an image. (→ page 28)

Selecting Menu Color [Menu Color Select]

You can choose between two color modes for menu color: color and monochrome.

Selecting Menu Display Time [Menu Display Time]

This option allows you to select how long the projector waits after the last touch of a button to turn off the menu.

The preset choices are “Manual”, “Auto 5 sec”, “Auto 15 sec”, and “Auto 45 sec”.

Selecting a Color for Background [Background]

Use this feature to display a blue/black screen when no signal is available.

[Setup - Options]

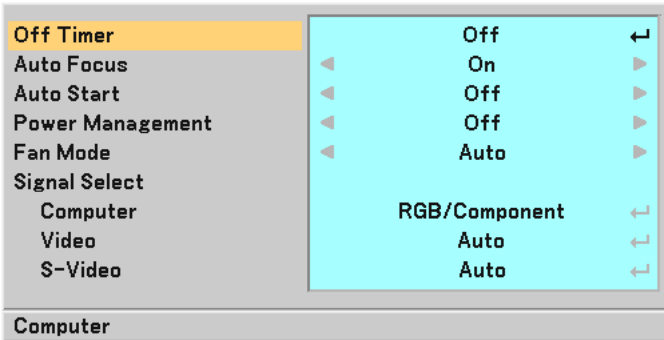

Setting Off Timer [Off Timer]

You can use the Off Timer feature to turn off the projector automatically at a preset time. Eight preset times can be selected: Off, 0:30, 1:00, 2:00, 4:00, 8:00, 12:00 and 16:00.

Enabling or Disabling Auto Focus [Auto Focus]

This option turns on or off the Auto Focus feature. (→ page 22)

NOTE:

When the "Auto Focus" is on, the Auto Focus function works instantly under the following conditions:

- When you turn on the power.
- When you change the zoom.
- When you reposition the projector.

Enabling Auto Start [Auto Start]

Turns the projector on automatically when the power cable is inserted into an active power outlet. This eliminates the need to always use the POWER button on the remote control or projector cabinet.

Last When the projector is turned off with the POWER button (placed into stand-by mode) and then the power cable is disconnected, Auto Start will not be activated after power (AC) is applied.
 When the projector is turned off with the "Direct Power Off" function or after power (AC) is removed (no stand-by mode), Auto Start will be activated after power (AC) is applied.
 The "Direct Power Off" function means you can turn off the power (AC) to the projector using a power strip equipped with a switch and a breaker.

Enabling Power Management [Power Management]

When this option is selected you can enable the projector to automatically turn off (at the selected time: 5min., 10min., 20min., 30min.) if there is no signal received by any input.

Enabling Fan Speed Mode [Fan Mode]

This option allows you to select two modes for fan speed: Auto mode and High speed mode.

Auto The built-in fans automatically run at a variable speed according to the internal temperature.
 High The built-in fans run at a fixed high speed.

When you wish to cool down the temperature inside the projector quickly, select [High].

NOTE: It is recommended that you select High speed mode if you continue to use the projector for consecutive days.

Selecting Signal Format [Signal Select]

[Computer]

Normally select [RGB/Component] and the projector automatically detects a component signal. Select [Scart] for the European Scart signal.

[Video & S-Video System Select]

This feature enables you to select video standards automatically or manually.

Normally select [Auto] and the projector will automatically detect the video standard.

In the case where the projector has difficulty detecting the video standard, select the appropriate video standard from the menu. This must be done for Video and S-Video respectively.

7 Menu Descriptions & Functions [Information]

Displays the status of the current signal and lamp usage. This item has three pages. The information included is as follows:

[Usage Time]

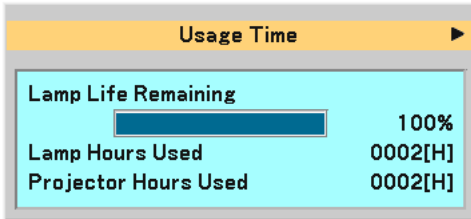

[Lamp Life Remaining] (%)*

[Lamp Hours Used] (H)

[Projector Hours Used] (H)

* The progress indicator shows the percentage of remaining bulb life.

The value informs you of the amount of lamp usage. When the remaining lamp time reaches 0, the Remaining Lamp Time bar indicator changes from 0% to 100 Hours and starts counting down.

If the remaining lamp time reaches 0 hours, the projector will not turn on regardless of whether the lamp mode is set to Normal or Eco.

Model	Lamp life(H)		Replacement lamp
	Normal	Eco	
8762	2000	2500	465-8762

[Source]

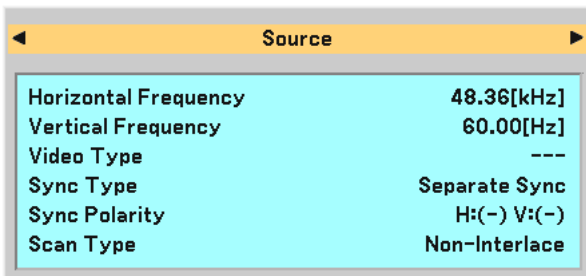

[Horizontal Frequency]

[Vertical Frequency]

[Video Type]

[Sync Type]

[Sync Polarity]

[Scan Type]

[Version]

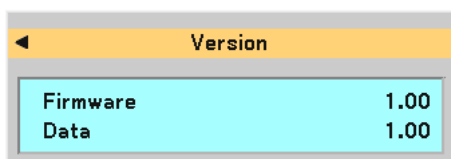

[Firmware] Version

[Data] Version

8 Menu Descriptions & Functions [Reset]

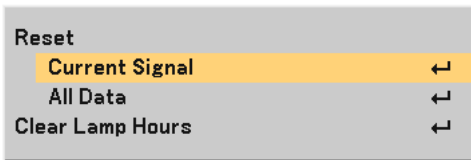

Returning to Factory Default [Reset]

The Factory Default feature allows you to change adjustments and settings to the factory preset for a (all) source (s) except the following:

[Current Signal]

Resets the adjustments for the current signal to the factory preset levels.

The items that can be reset are: [Preset], [Brightness], [Contrast], [Color], [Hue], [Sharpness], [Aspect Ratio], [Horizontal Position], [Vertical Position], [Clock], [Phase], [Noise Reduction], [Telecine] and [Volume].

[All Data]

Reset all the adjustments and settings for all the signals to the factory preset.

All items can be reset except [Language], [Background], [Communication Speed], [Security], [Lamp Life Remaining], [Lamp Hours Used], and [Projector Hours Used].

To reset the lamp usage time, see “Clearing Lamp Hour Meter [Clear Lamp Hours]” below.

Clearing Lamp Hour Meter [Clear Lamp Hours]

Resets the lamp clock back to zero. Selecting this option displays submenu for a confirmation.

NOTE: The projector will turn off and go into standby mode after 2100 hours (up to 2600 hours in Eco mode) of service. If this happens, press the HELP button on the remote control for 10 seconds to reset the lamp clock back to zero. When the lamp time clock is reset to zero, the LAMP indicator goes out. Do this only after replacing the lamp.

6. Maintenance

This section describes the simple maintenance procedures you should follow to clean the focus sensor, lens and replace the lamp.

① Cleaning the Lens and Focus Sensor

Cleaning the lens

Use a blower or lens paper to clean the lens, and be careful not to scratch or mar the lens.

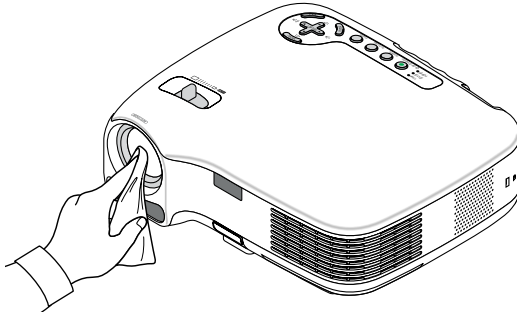

Cleaning the focus sensor

Use a blower or lens paper to clean the focus sensor.

Keep finger prints off the focus sensor. Leaving finger prints in the focus sensor might cause poor focus or short auto focus range.

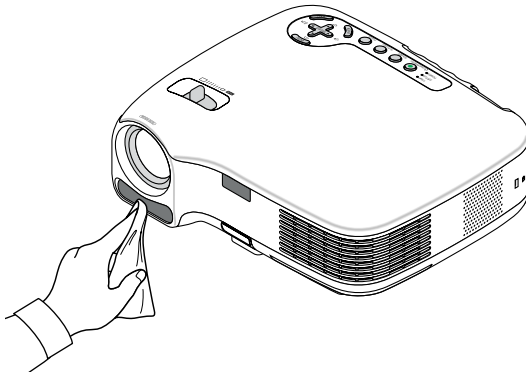

② Cleaning the Cabinet

1. Turn off the projector before cleaning.
2. Vacuum the ventilation inlet of the cabinet.

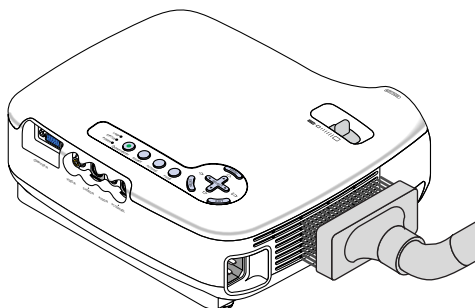

③ Replacing the Lamp

After your lamp has been operating for 2000 hours (up to 2500 hours in Eco mode) or longer, the LAMP indicator in the cabinet will blink red and the message **[The lamp has reached the end of its usable life. Please replace the lamp.]** will appear. Even though the lamp may still be working, replace it at 2000 (up to 2500 hours in Eco mode) hours to maintain optimal projector performance. After replacing the lamp, be sure to clear the lamp hour meter. (→ page 45)

⚠ CAUTION

- DO NOT TOUCH THE LAMP immediately after it has been used. It will be extremely hot. Turn the projector off and then disconnect the power cable. Allow at least one hour for the lamp to cool before handling.
- DO NOT REMOVE ANY SCREWS except two lamp case screws. You could receive an electric shock.
- Do not break the glass on the lamp housing.
Keep finger prints off the glass surface on the lamp housing. Leaving finger prints in the glass surface might cause an unwanted shadow and poor picture quality.
- The projector will turn off and go into standby mode after 2100 (up to 2600 hours in Eco mode) hours of service. If this happens, be sure to replace the lamp. If you continue to use the lamp after 2000 hours (up to 2500 hours in Eco mode) of use, the lamp bulb may shatter, and pieces of glass may be scattered in the lamp case. Do not touch them as the pieces of glass may cause injury. If this happens, contact your dealer for lamp replacement.

To replace the lamp:

Optional lamp and tools needed for replacement:

- Replacement lamp 465-8762
- Phillips screwdriver or equivalent

1. Place the projector on a soft cloth and turn it over to access the lamp cover on the bottom.

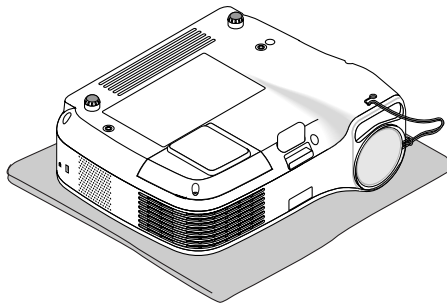

2. Loosen the lamp cover screw until the screwdriver goes into a freewheeling condition and remove the lamp cover.

The lamp cover screw is not removable.

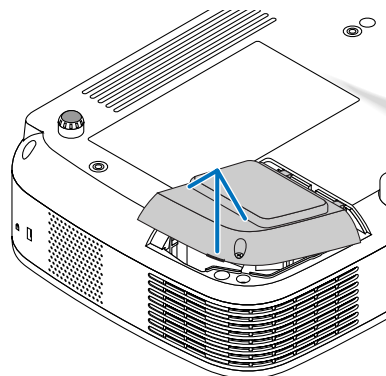
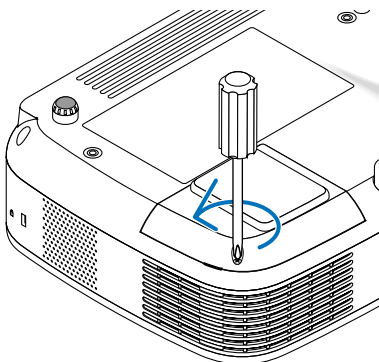

3. Loosen the two screws securing the lamp housing until the phillips screwdriver goes into a freewheeling condition. The two screws are not removable. Remove the lamp housing by holding it.

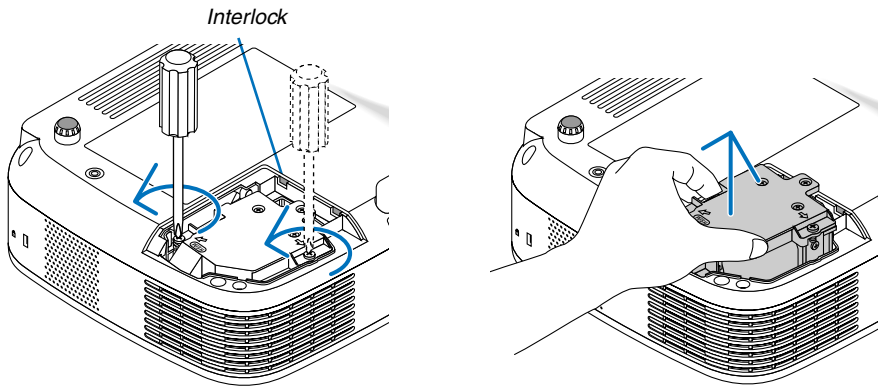

NOTE: There is an interlock on this case to prevent the risk of electrical shock. Do not attempt to circumvent this interlock.

4. Push the part labeled "PUSH" and insert a new lamp housing until the lamp housing is plugged into the socket.

CAUTION

Do not use a lamp other than the Dukane replacement lamp.
Order this from you dealer.

- Secure it in place with the two screws.
Be sure to tighten the screws.

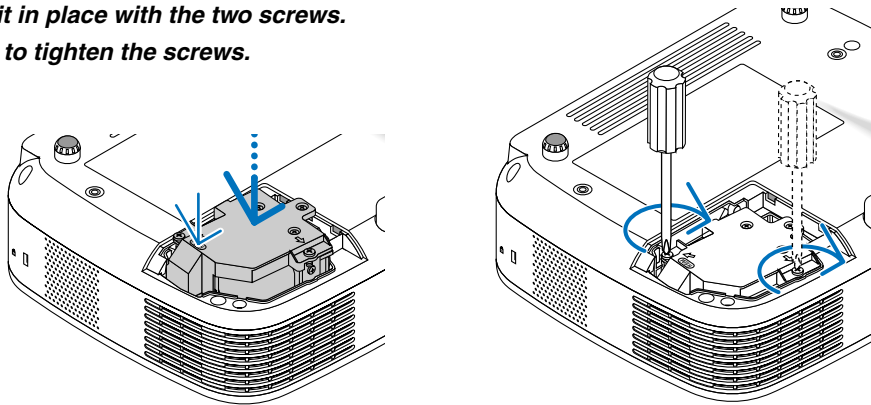

5. Reattach the lamp cover.

6. Tighten the lamp cover screw.
Be sure to tighten the screw.

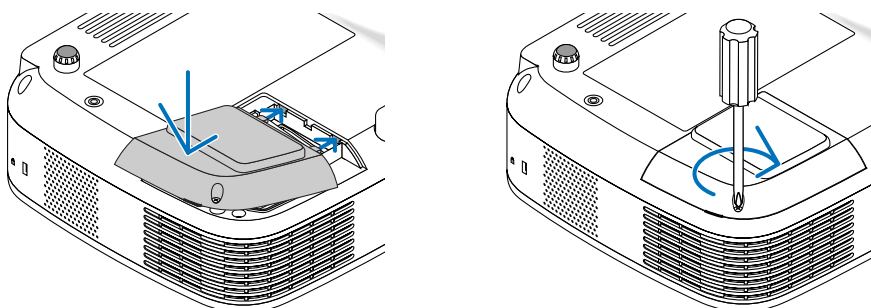

7. Connect the supplied power cable and turn on the projector.

8. Finally, select the menu → [Reset] → [Clear Lamp Hours] to reset the lamp usage hours.

NOTE: When the lamp exceeds 2100 hours (up to 2600 hours in Eco mode) of service, the projector cannot turn on and the menu is not displayed.

If this happens, press the HELP button on the remote control for 10 seconds to reset the lamp clock back to zero.

When the lamp time clock is reset to zero, the LAMP indicator goes out.

7. Appendix

1 Troubleshooting

This section helps you resolve problems you may encounter while setting up or using the projector.

Indicator Messages

Power Indicator

Indicator Condition			Projector Condition	Note
Off			The main power is off	–
Blinking light	Green	0.5 sec On, 0.5 sec Off	The projector is getting ready to turn on.	Wait for a moment.
		2.5 sec On, 0.5 sec Off	Off Timer is enabled.	–
	Orange	0.5 sec On, 0.5 sec Off	The projector is cooling down.	Wait for a moment.
Steady light	Green		The projector is turned on.	–
	Orange		The projector is in Standby.	–

Status Indicator

Indicator Condition			Projector Condition	Note
Off			Normal	–
Blinking light	Red	1 cycle (0.5 sec On, 2.5 sec Off)	Lamp cover error or lamp housing error	Replace the lamp cover or lamp housing correctly.
		2 cycle (0.5 sec On, 0.5 sec Off)	Temperature error	The projector is overheated. Move the projector to a cooler location.
		4 cycle (0.5 sec On, 0.5 sec Off)	Fan error	Fans will not work correctly.
		6 cycle (0.5 sec On, 0.5 sec Off)	Lamp error	Lamp fails to light. Wait a full minute and then turn on again.
	Green		Re-firing the lamp (The projector is cooling down.)	The projector is re-firing. Wait for a moment.
Steady light	Orange		Control Panel Lock is on.	You have pressed cabinet button when Control Panel Lock is on.

Lamp Indicator

Indicator Condition			Projector Condition	Note
Off			Normal	–
Blinking light	Red		Lamp has reached its end of life. Lamp replacement message will be displayed.	Replace the lamp.
Steady light	Red		Lamp has been used beyond its limit. The projector will not turn on until the lamp is replaced.	Replace the lamp.
	Green		Lamp mode is set to Eco mode	–

Common Problems & Solutions (→ "Power/Status/Lamp Indicator" on page 50.)

Problem	Check These Items
Does not turn on	<ul style="list-style-type: none"> • Check that the power cable is plugged in and that the power button on the projector cabinet or the remote control is on. (→ page 16, 17) • Ensure that the lamp cover is installed correctly. (→ page 48) • Check to see if the projector has overheated. If there is insufficient ventilation around the projector or if the room where you are presenting is particularly warm, move the projector to a cooler location. • Check to see if the lamp usage exceeds 2100 hours (up to 2600 hours : Eco mode). If so, replace the lamp. After replacing the lamp, reset the lamp hours used.(→ page 45) • The lamp may fail to light. Wait a full minute and then turn on the power again.
Will turn off	<ul style="list-style-type: none"> • Ensure that the Power Management or Off Timer is off. (→ page 43)
No picture	<ul style="list-style-type: none"> • Use the VIDEO, the S-VIDEO or the COMPUTER button on the remote control to select your source (Computer, Video or S-Video). (→ page 19) If there is still no picture, press the button again. • Ensure your cables are connected properly. • Use menus to adjust the brightness and contrast. (→ page 38) • Check to see if the image is muted. (→ page 28) • Remove the lens cap. • Reset the settings or adjustments to factory preset levels using the [Reset] in the Menu. (→ page 45) • Enter your registered keyword if the Security function is enabled. (→ page 28) • Be sure to connect the projector and notebook PC while the projector is in standby mode and before turning on the power to the notebook PC. In most cases the output signal from the notebook PC is not turned on unless connected to the projector before being powered up. <ul style="list-style-type: none"> * If the screen goes blank while using your remote control, it may be the result of the computer's screen-saver or power management software. • See also the next page.
Picture suddenly becomes dark	<ul style="list-style-type: none"> • When one of the following happens, the Lamp mode automatically changes from Normal to Eco. <ul style="list-style-type: none"> * When there are no signals (blue or black screen) → To return to the Normal mode, select another available source. * When the room where you' re presenting is particularly warm → Move the projector to a cooler location.
Color tone or hue is unusual	<ul style="list-style-type: none"> • Check if an appropriate color is selected in [Wall Color]. If not, select an appropriate option. (→ page 40) • Adjust [Hue] in [Picture]. (→ page 38)
Image isn't square to the screen	<ul style="list-style-type: none"> • Reposition the projector to improve its angle to the screen. (→ page 20, 21) • Use the Keystone correction function to correct the trapezoid distortion. (→ page 25)
Picture is blurred	<ul style="list-style-type: none"> • Make sure that focus is appropriate. • Reposition the projector to improve its angle to the screen. (→ page 20, 21) • Ensure that the distance between the projector and screen is within the adjustment range of the lens. (→ page 10) • Make sure that the distance between the focus sensor and the screen is within the effective range of the Auto Focus. (→ page 22) • Make sure that the requirements for the Auto Focus are met. (→ page 22) • Condensation may form on the lens if the projector is cold, brought into a warm place and is then turned on. Should this happen, let the projector stand until there is no condensation on the lens.
Image is scrolling vertically, horizontally or both	<ul style="list-style-type: none"> • Use the VIDEO, the S-VIDEO or the COMPUTER button on the remote control to select your source (Video, S-Video or Computer). (→ page 19) • Adjust the computer image manually with the Horizontal and Vertical in the [Image Options] → [Position/Clock]. (→ page 39)
Remote control does not work	<ul style="list-style-type: none"> • Install new batteries. (→ page 8) • Make sure there are no obstacles between you and the projector. • Stand within 22 feet (7 m) of the projector. (→ page 8)
Indicator is lit or blinking	<ul style="list-style-type: none"> • See the POWER/STATUS/LAMP Indicator. (→ page 50)
Cross color in RGB mode	<ul style="list-style-type: none"> • Press the AUTO ADJ. button on the projector cabinet or the remote control. (→ page 26) • Adjust the computer image manually with [Clock] and [Phase] in [Image Options] → [Position/Clock] in the menu. (→ page 39)

For more information contact your dealer.

If there is no picture, or the picture is not displayed correctly.

- Power on process for the projector and the PC.

Be sure to connect the projector and notebook PC while the projector is in standby mode and before turning on the power to the notebook PC.

In most cases the output signal from the notebook PC is not turned on unless connected to the projector before being powered up.

NOTE: You can check the horizontal frequency of the current signal in the projector's menu under Information. If it reads "0kHz", this means there is no signal being output from the computer. See page 44 or go to next step.

- Enabling the computer's external display.

Displaying an image on the notebook PC's screen does not necessarily mean it outputs a signal to the projector. When using a PC compatible laptop, a combination of function keys will enable/disable the external display. Usually, the combination of the 'Fn' key along with one of the 12 function keys gets the external display to come on or off. For example, NEC laptops use Fn + F3, while Dell laptops use Fn + F8 key combinations to toggle through external display selections.

- Non-standard signal output from the computer

If the output signal from a notebook PC is not an industry standard, the projected image may not be displayed correctly. Should this happen, deactivate the notebook PC's LCD screen when the projector display is in use. Each notebook PC has a different way of deactivate/reactivate the local LCD screens as described in the previous step. Refer to your computer's documentation for detailed information.

- Image displayed is incorrect when using a Macintosh

When using a Macintosh with the projector, set the DIPswitch of the Mac adapter (not supplied with the projector) according to your resolution. After setting, restart your Macintosh for the changes to take affect.

For setting display modes other than those supported by your Macintosh and the projector, changing the DIP switch on a Mac adapter may bounce an image slightly or may display nothing. Should this happen, set the DIP switch to the 13" fixed mode and then restart your Macintosh. After that, restore the DIP switches to a displayable mode and then restart the Macintosh again.

NOTE: A Video Adapter cable manufactured by Apple Computer is needed for a PowerBook which does not have a mini D-Sub 15-pin connector.

- Mirroring on a PowerBook

* When using the projector with a Macintosh PowerBook, output may not be set to 1024 x 768 unless "mirroring" is off on your PowerBook. Refer to owner's manual supplied with your Macintosh computer for mirroring.

- Folders or icons are hidden on the Macintosh screen

Folders or icons may not be seen on the screen. Should this happen, select [View] → [Arrange] from the Apple menu and arrange icons.

② Specifications

This section provides technical information about the 8762 projector's performance.

Model Number	8762
Optical	
DMD	Single Chip Digital Micromirror Device (DMD)
Resolution	1024 x 768 pixels* up to SXGA+ (1400 x 1050) with scaling technology
Lens	Manual zoom and auto focus (effective range: 1.4 m - 5.5 m) / manual focus F2.4 - 2.6 f=25.7 mm - 30.8 mm
Lamp	200W AC (170W Eco mode)
Image Size (Diagonal)	30" - 300" diagonal
Projection Distance	42" - 438" (wide) - 51" - 524" (tele) 1.1 - 11.1 m (wide) - 1.3- 13.3 m (tele)
Projection Angle	11.6° - 12.1° (wide) / 9.7° - 10.0° (tele)
Electrical	
Inputs	1 VGA shared with component video (Mini D-Sub 15 Pin), 1 S-Video (Mini DIN 4 Pin), 1 Video (RCA), 1 Stereo Mini Audio, 1 PC Control (Mini DIN 8 Pin)
Video Compatibility	NTSC, NTSC4.43, PAL, PAL-60, PAL-N, PAL-M, SECAM, Component : 1080i, 720p, 576p, 480p, 576i, 480i
Scan Rate	Horizontal: 15 kHz to 100 kHz (RGB: 24 kHz or over) Vertical: 50 Hz to 85 Hz
Color Reproduction	16.7 million colors simultaneously, Full color
Horizontal Resolution	NTSC / NTSC4.43/PAL / PAL-60/PAL-N/PAL-M/YCbCr: 540 TV lines SECAM: 300 TV lines RGB: 1024 dots (H) x 768 dots (V)
External Control	IR, RS232C
Sync Compatibility	Separate Sync / Composite Sync / Sync on G
Built-in Speaker	1W (monaural)
Power Requirement	100 - 240V AC, 50 / 60 Hz
Input Current	2.8 - 1.3A
Power Consumption	260W in Lamp Normal mode, 230W in Lamp Eco mode, 8.0W in Standby mode.

* Effective pixels are more than 99.99%.

Mechanical

Installation Orientation	Desktop/Front, Desktop/Rear, Ceiling/Front, Ceiling/Rear
Dimensions	10.2" (W) x 3.5" (H) x 8.2" (D) 260 mm (W) x 89 mm (H) x 208.5 mm (D) (not including protrusions)
Net Weight	4.4 lbs / 2.0 kg
Environmental Considerations	Operational Temperatures: 41°F to 104°F / 5°C to 40°C (Eco mode selected automatically at 95°F to 104°F/35°C to 40°C) 20% to 80% humidity (non-condensing) Storage Temperatures: 14°F to 122°F (-10°C to 50°C), 20% to 80% humidity (non-condensing)
Regulations	<i>For United States:</i> UL Approved (UL 60950-1) Meets FCC Class B requirements <i>For Canada:</i> UL Approved (CSA 60950-1) Meets DOC Canada Class B requirements <i>For Australia/New Zealand:</i> Meets AS/NZS CISPR.22 Class B <i>For Europe:</i> Meets EMC Directive (EN55022, EN55024, EN61000-3-2, EN61000-3-3) Meets Low Voltage Directive (EN60950-1, TUV GS Approved) CE

For additional information visit:

US : <http://www.dukcorp.com/av>

The specifications are subject to change without notice.

3 Cabinet Dimensions

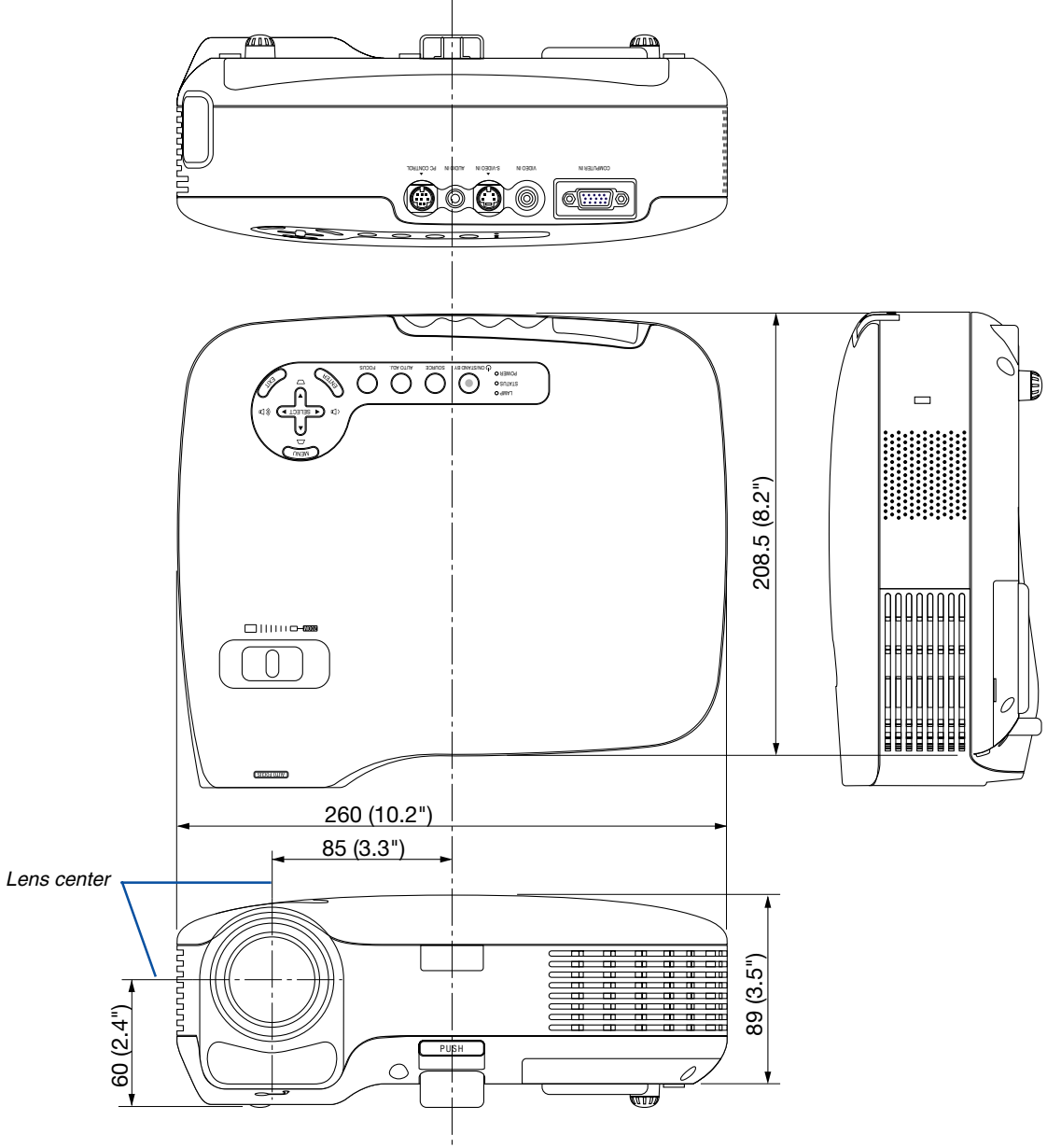

Unit: mm (inch)

④ Pin Assignments of D-Sub COMPUTER Input Connector

Mini D-Sub 15 Pin Connector

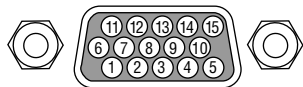

Signal Level
 Video signal : 0.7Vp-p (Analog)
 Sync signal : TTL level

Pin No.	RGB Signal (Analog)	YCbCr Signal
1	Red	Cr
2	Green or Sync on Green	Y
3	Blue	Cb
4	Ground	
5	Ground	
6	Red Ground	Cr Ground
7	Green Ground	Y Ground
8	Blue Ground	Cb Ground
9	No Connection	
10	Sync Signal Ground	
11	SCART Sync	
12	Bi-directional DATA (SDA)	
13	Horizontal Sync or Composite Sync	
14	Vertical Sync	
15	Data Clock	

5 Compatible Input Signal List

Horizontal: 15 kHz to 100 kHz (RGB: 24 kHz or over)

Vertical: 50 Hz to 85 Hz

Signal	Resolution (Dots)	Frequency H. (kHz)	Refresh Rate (Hz)
NTSC	–	15.73	60.00
PAL	–	15.63	50.00
PAL60	–	15.73	60.00
SECAM	–	15.63	50.00
VESA	640 × 480	31.47	59.94
IBM	640 × 480	31.48	59.95
MAC	640 × 480	35.00	66.67
VESA	640 × 480	37.86	72.81
VESA	640 × 480	37.50	75.00
IBM	640 × 480	39.38	75.00
VESA	640 × 480	43.27	85.01
IBM	720 × 350	31.47	70.08
VESA	800 × 600	35.16	56.25
VESA	800 × 600	37.88	60.32
VESA	800 × 600	48.08	72.19
VESA	800 × 600	46.88	75.00
VESA	800 × 600	53.67	85.06
MAC	832 × 624	49.72	74.55
VESA	1024 × 768	48.36	60.00
VESA	1024 × 768	56.48	70.07
MAC	1024 × 768	60.24	74.93
VESA	1024 × 768	60.02	75.03
VESA	1024 × 768	68.68	85.00
# VESA	1152 × 864	67.50	75.00
# SUN	1152 × 900	61.80	65.95
# VESA	1280 × 960	60.00	60.00
# VESA	1280 × 1024	63.98	60.02
# MAC	1280 × 1024	69.87	65.18
# SXGA+	1400 × 1050	–	60.00
# HDTV (1080i)(1125i)	1920 × 1080	33.75	60.00 Interlace
# HDTV (1080i)(1125i)	1920 × 1080	28.13	50.00 Interlace
# HDTV (720p)(750p)	1280 × 720	45.00	60.00 Progressive
# HDTV (720p)	1280 × 720	37.50	50.00 Progressive
SDTV(576p)(625p)	–	31.25	50.00 Progressive
SDTV (480p)(525p)	–	31.47	59.94 Progressive
DVD YCbCr	–	15.73	59.94 Interlaced
DVD YCbCr	–	15.63	50.00 Interlaced

: Signals above flagged with # are compressed with scaling technology.

NOTE: Signals other than those specified in the table above may not be displayed correctly. If this should happen, change the refresh rate or resolution on your PC. Refer to Display Properties help section of your PC for procedures.

6 PC Control Codes and Cable Connection

PC Control Codes

Function	Code Data								
POWER ON	02H	00H	00H	00H	00H	02H			
POWER OFF	02H	01H	00H	00H	00H	03H			
INPUT SELECT COMPUTER	02H	03H	00H	00H	02H	01H	01H	09H	
INPUT SELECT VIDEO	02H	03H	00H	00H	02H	01H	06H	0EH	
INPUT SELECT S-VIDEO	02H	03H	00H	00H	02H	01H	0BH	13H	
PICTURE MUTE ON	02H	10H	00H	00H	00H	12H			
PICTURE MUTE OFF	02H	11H	00H	00H	00H	13H			
SOUND MUTE ON	02H	12H	00H	00H	00H	14H			
SOUND MUTE OFF	02H	13H	00H	00H	00H	15H			

NOTE: Contact your local dealer for a full list of the PC Control Codes if needed.

Cable Connection

Communication Protocol

Baud rate 38400 bps
 Data length 8 bits
 Parity No parity
 Stop bit One bit
 X on/off None
 Communications procedure Full duplex

NOTE: Depending on the equipment, a lower baud rate may be recommended for long cable runs.

PC Control Connector (DIN-8P)

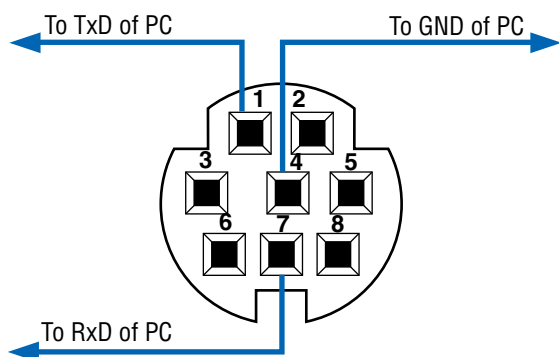

7 Troubleshooting Check List

Before contacting your dealer or service personnel, check the following list to be sure repairs are needed also by referring to the "Troubleshooting" section in your user's manual. This checklist below will help us solve your problem more efficiently.

* Print the following pages.

Frequency of occurrence always sometimes (How often? _____) other (_____)

Power

- No power (POWER indicator does not light green) See also "Status Indicator (STATUS)".
 - Power cable's plug is fully inserted into the wall outlet.
 - The power cable has been unplugged and plugged quickly during projection.
 - Lamp cover is installed correctly .
 - Lamp Hour Used (lamp operation hours) was cleared after lamp replacement.
 - No power even though you press and hold the POWER button for a minimum of 1 second.
- Shut down during operation.
 - Power cable's plug is fully inserted into the wall outlet.
 - Lamp cover is installed correctly .
 - Power Management is turned off (only models with the Power Management function).
 - Off Timer is turned off (only models with the Off Timer function).

Video and Audio

- No image is displayed from your PC or video equipment to the projector.
 - Still no image even though you connect the projector to the PC first, then start the PC.
 - Enabling your notebook PC's signal output to the projector.
 - *A combination of function keys will enable/disable the external display. Usually, the combination of the "Fn" key along with one of the 12 function keys turns the external display on or off.*
- No image (blue background, black background).
 - Still no image even though you press the AUTO ADJ. button.
 - Still no image even though you carry out [Reset] in the projector's menu.
 - Signal cable's plug is fully inserted into the input connector
 - A message appears on the screen. (_____)
 - The source connected to the projector is active and available.
 - Still no image even though you adjust the brightness and/or the contrast.
 - Input source's resolution and frequency are supported by the projector.
- Image is too dark.
 - Remains unchanged even though you adjust the brightness and/or the contrast.
- Image is distorted.
 - Image appears to be trapezoidal (unchanged even though you carry out the [Keystone] adjustment).
- Parts of the image are lost.
 - Still unchanged even though you press the AUTO ADJ. button.
 - Still unchanged even though you carry out [Reset] in the projector's menu.
- Image is shifted in the vertical or horizontal direction.
 - Horizontal and vertical positions are correctly adjusted on a computer signal.
 - Input source's resolution and frequency are supported by the projector.
 - Some pixels are lost.
- Image is flickering.
 - Still unchanged even though you press the AUTO ADJ. button.
 - Still unchanged even though you carry out [Reset] in the projector's menu.
 - Image shows flickering or color drift on a computer signal.
- Image appears blurry or out of focus.
 - Auto Focus is turned on.
 - There are no objections between the focus sensor and the screen. The throw distance is within 1.4 to 5.5 m/55.1" to 216.5" Image is projected onto the screen.
 - Still unchanged even though you adjusted the focus manually.
- No sound.
 - Audio cable is correctly connected to the audio input of the projector.
 - Still unchanged even though you adjusted the volume level.

Other

- Remote control does not work.
 - No obstacles between the sensor of the projector and the remote control.
 - Projector is placed near a fluorescent light that can disturb the infrared remote controls.
 - Batteries are new and are not reversed in installation.
- Buttons on the projector cabinet do not work (only models with the Key Lock function).
 - Control Panel Lock is not turned on or is disabled in the menu.
 - Still unchanged even though you press and hold the EXIT button for a minimum of 10 seconds.

In the space below please describe your problem in detail.

Information on application and environment where your projector is used

Projector

Model number:
 Serial No.:
 Date of purchase:
 Lamp operating time (hours):
 Lamp Mode: Normal Eco
 Information on input signal:
 Horizontal synch frequency [] kHz
 Vertical synch frequency [] Hz
 Synch polarity H (+) (-)
 V (+) (-)
 Synch type Separate Composite
 Sync on Green
 STATUS Indicator:
 Steady light Orange Green
 Flashing light [] cycles
 Remote control model number:

Installation environment

Screen size: inch
 Screen type: White matte Beads Polarization
 Wide angle High contrast
 Throw distance: feet/inch/m
 Orientation: Ceiling mount Desktop
 Power outlet connection:
 Connected directly to wall outlet
 Connected to power cord extender or other (the number of connected equipment _____)
 Connected to a power cord reel or other (the number of connected equipment _____)

Computer

Manufacturer:
 Model number:
 Notebook PC / Desktop
 Native resolution:
 Refresh rate:
 Video adapter:
 Other:

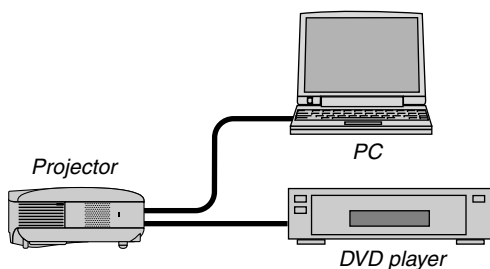

Signal cable

NEC standard or other manufacturer's cable?
 Model number: Length: inch/m
 Distribution amplifier
 Model number:
 Switcher
 Model number:
 Adapter
 Model number:

Video equipment

VCR, DVD player, Video camera, Video game or other
 Manufacturer:
 Model number:

Dukane Corporation
Audio Visual Products Division
2900 Dukane Drive
St. Charles, IL 60174-3395
E-mail: avsales@dukcorp.com

Phone: (630) 762-4040
Orders: (800) 676-2485
Fax: (630) 584-5156
Parts & Service: (800) 676-2487
Fax: (630) 584-0984

Audio Visual Products

DUKANE

Part # 401-8762-00